

# Formaufbauten

Wir bearbeiten Ihre Stücklisten in Ihren bevorzugten Artikelbezeichnungen!

B/L	156	196	246	296	346	396	446	496	546	596	696
156	■	■	■								
190			■								
196		■		■	■	■					
246			■	■	■	■	■				
296				■	■	■	■				
346					■	■	■	■	■	■	
396						■	■	■	■	■	
446							■	■			
496								■		■	■
596										■	

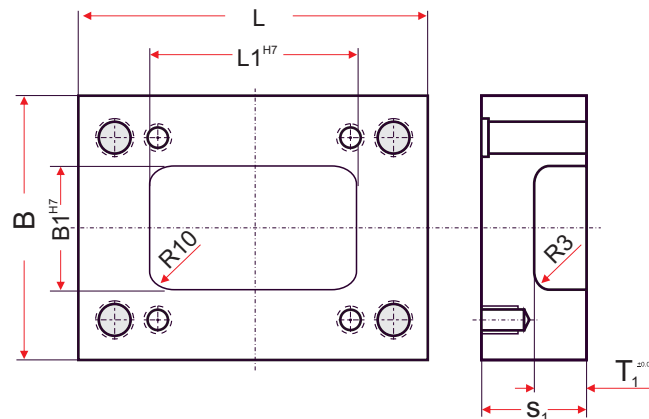

B/L	B1/L1	S <sub>1</sub>						
		36	46	56	66	76	96	116
246X246	155X155	*	*	*	*	*		
246X296	155X195	*	*	*	*	*		
246X346	155X245	*	*	*	*	*		
296X296	195X195	*	*	*	*	*		
296X346	189X245	*	*	*	*	*		
296X396	195X295	*	*	*	*	*		
346X346	245X245		*	*	*	*	*	
346X446	217X295		*	*	*	*	*	
396X396	245X245			*	*	*	*	*
396X446	245X295			*	*	*	*	*
396X496	245X345			*	*	*	*	*

S <sub>1</sub>	T <sub>1</sub>
36	16.8
46	21.8
56	26.8
66	26.8
76	35.8
96	45.8
116	55.8

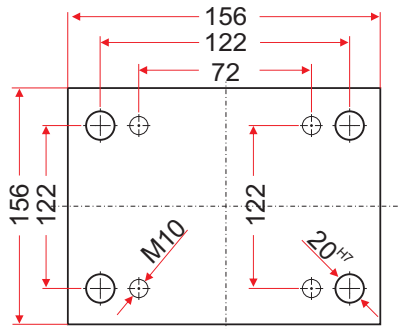

# 156.156

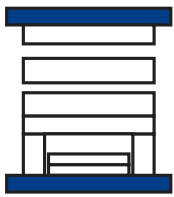

W801

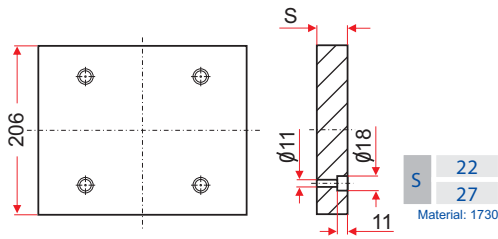

W810/K10/F10  
W811/K11/F15

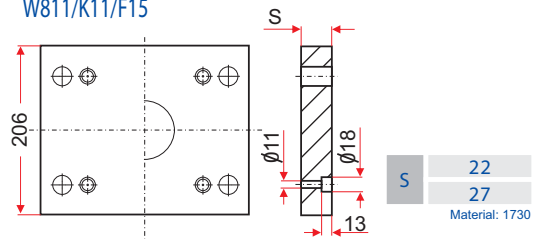

W820/K20/F50

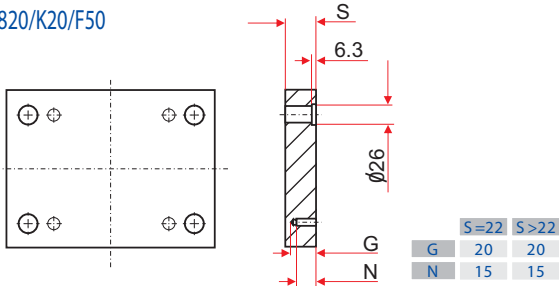

	Material			
	1.1730	1.2311	1.2738	1.2344
22	*	*	*	*
27	*	*	*	*
36	*	*	*	*
46	*	*	*	*
56	*	*	*	*
66	*	*	*	*
76	*	*	*	*
86	*	*	*	*
96	*	*	*	*

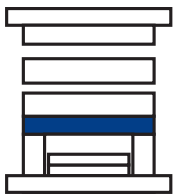

W803

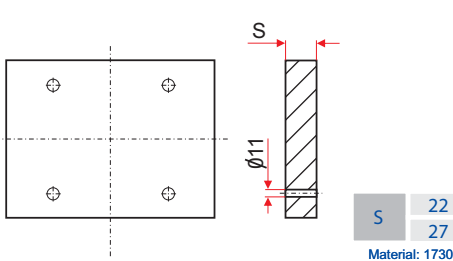

W830/K30/F60

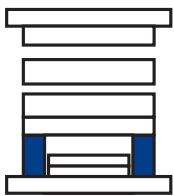
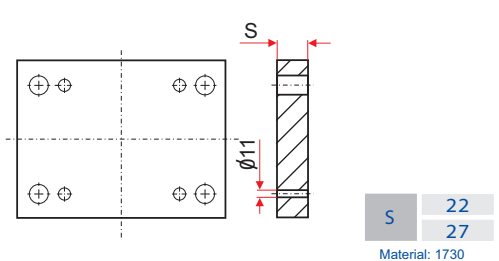

W804

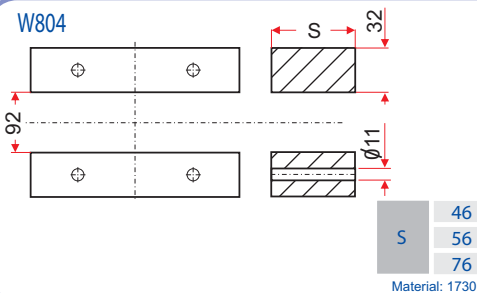

W840/K40/F70

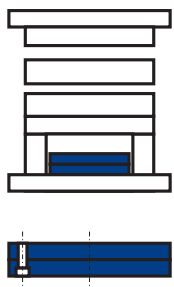
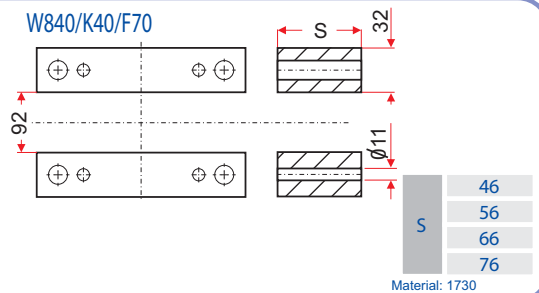

W860/70  
K60/70  
F90

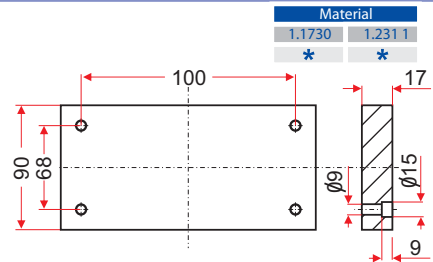
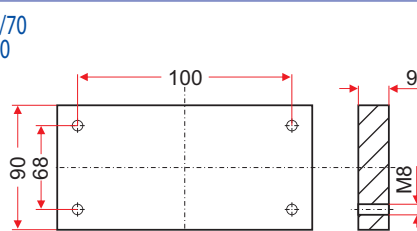

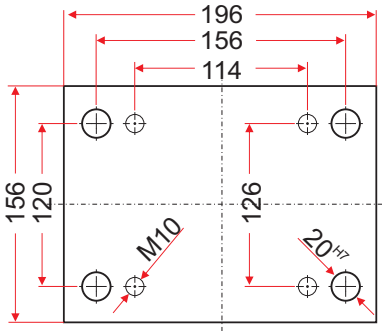

# 156.196



W801

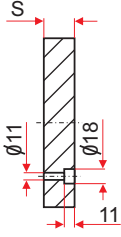
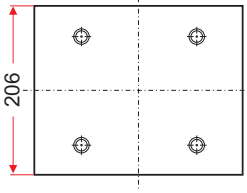

S	22
S	27

Material: 1730

W810/K10/F10  
W811/K11/F15

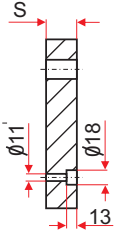
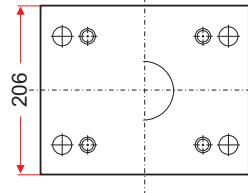

S	22
S	27

Material: 1730



W820/K20/F50

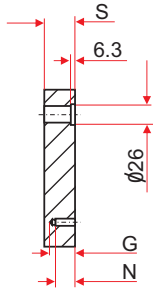
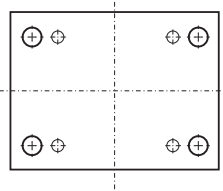

S=22		S>22	
G	20	20	
N	15	15	

Material	Material			
	1.1730	1.2311	1.2738	1.2344
S	*	*	*	*
22	*	*	*	*
27	*	*	*	*
36	*	*	*	*
46	*	*	*	*
56	*	*	*	*
66	*	*	*	*
76	*	*	*	*
86	*	*	*	*
96	*	*	*	*



W803

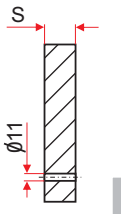
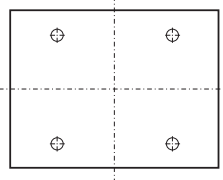

PS	
S	22
S	27

Material: 1730

W830/K30/F60

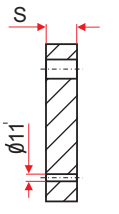
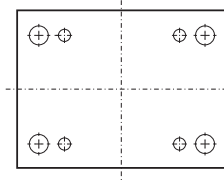

S	22
S	27

Material: 1730

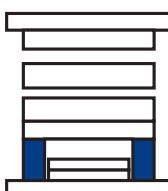

W804

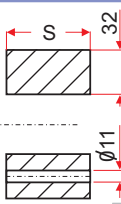
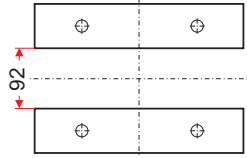

S	46
S	56
S	76

Material: 1730

W840/K40/F70

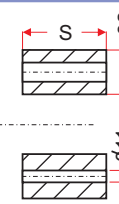
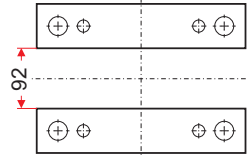

S	46
S	56
S	66
S	76

Material: 1730

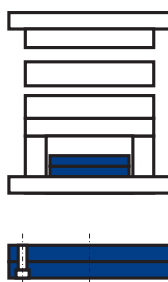

W860/70  
K60/70  
F90

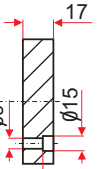
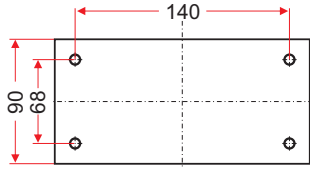
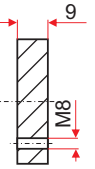
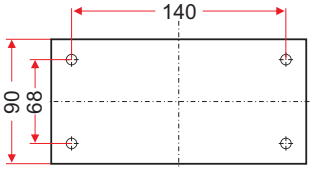

Material	
1.1730	1.2311
*	*

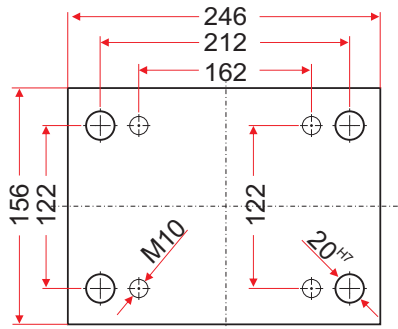

# 156.246

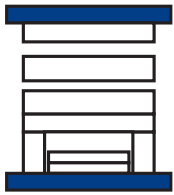

W801

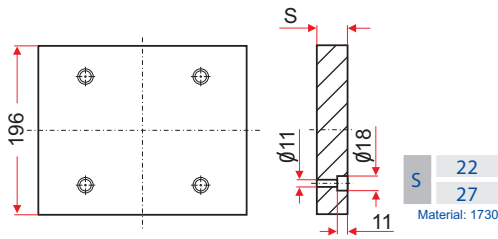

W810/K10/F10  
W811/K11/F15

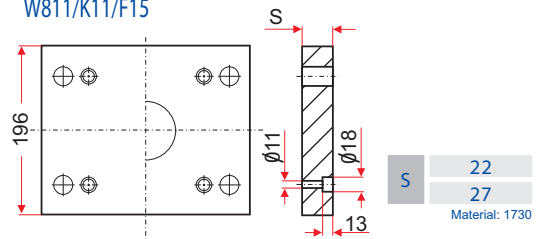

W820/K20/F50

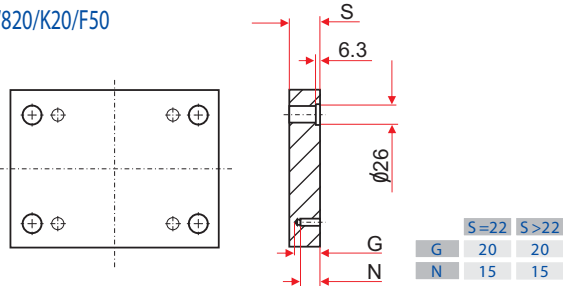

S	Material			
	1.1730	1.2311	1.2738	1.2344
22	*	*	*	
27	*	*	*	*
36	*	*	*	*
46	*	*	*	*
56	*	*	*	
66	*	*	*	
76	*	*	*	
86	*	*	*	
96	*	*		

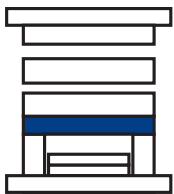

W803

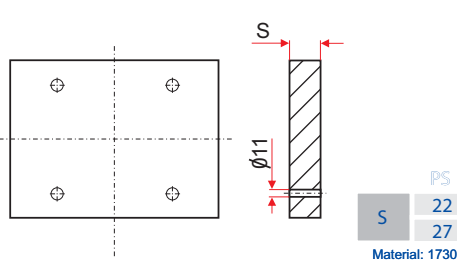

W830/K30/F60

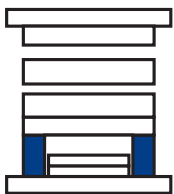
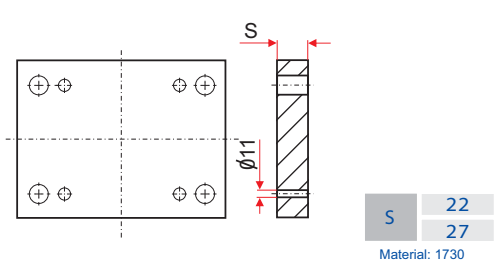

W804

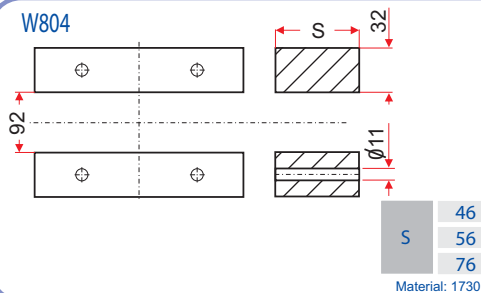

W840/K40/F70

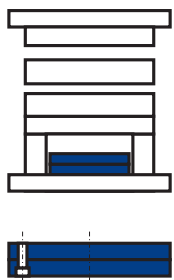
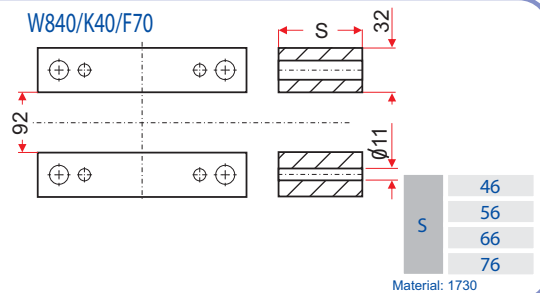

W860/70  
K60/70  
F90

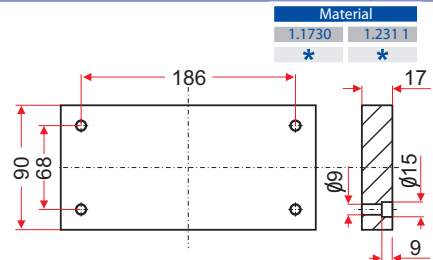
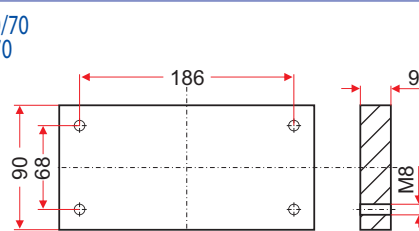

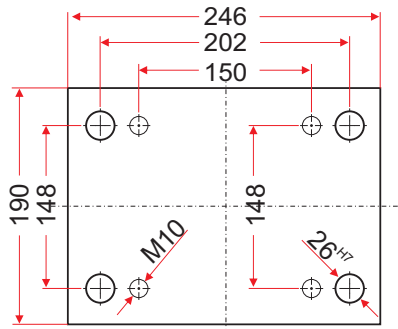

# 190.246

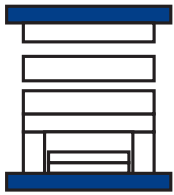

W801

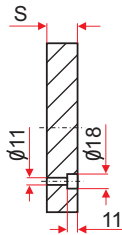
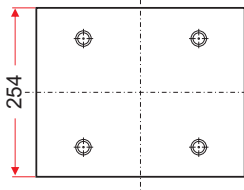

S	22
	27

Material: 1730

W810/K10/F10  
W811/K11/F15

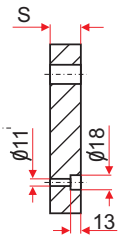
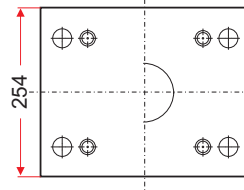

S	22
	27

Material: 1730



W820/K20/F50

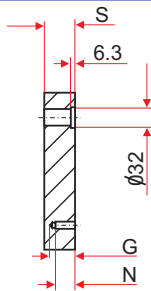
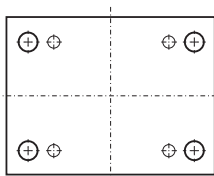

S=22		S>22	
G	20	20	
N	15	15	

S	Material			
	1.1730	1.2311	1.2738	1.2344
22	*	*	*	
27	*	*	*	*
36	*	*	*	*
46	*	*	*	*
56	*	*	*	
66	*	*	*	
76	*	*	*	
86		*		
96	*	*	*	
116	*	*		

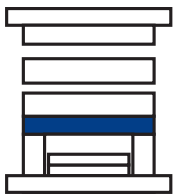

W803

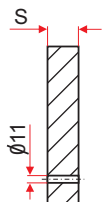
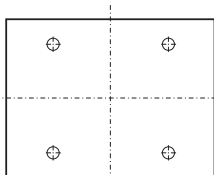

S	22
	27
	36

Material: 1730

W830/K30/F60

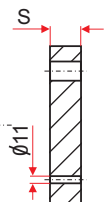
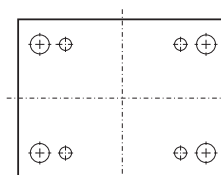

S	22
	27
	36

Material: 1730

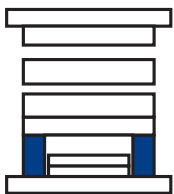

W804

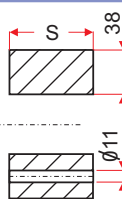
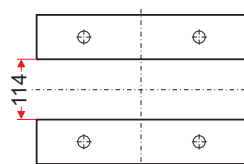

S	46
	56
	76

Material: 1730

W840/K40/F70

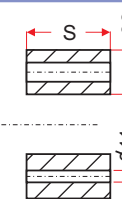
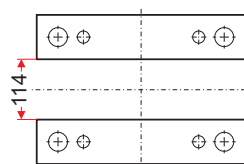

S	46
	56
	66
	76

Material: 1730

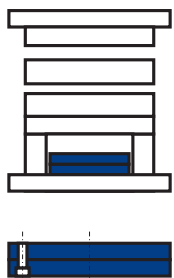

W860/70  
K60/70  
F90

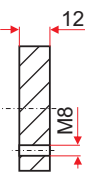
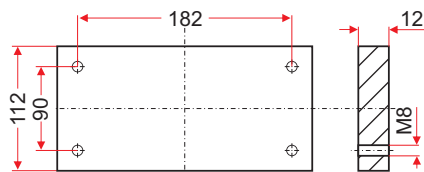

Material	
1.1730	1.2311
*	*

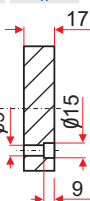
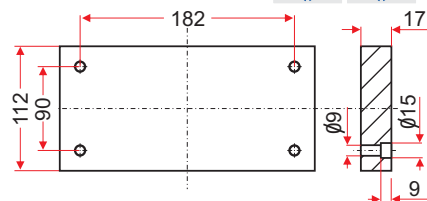

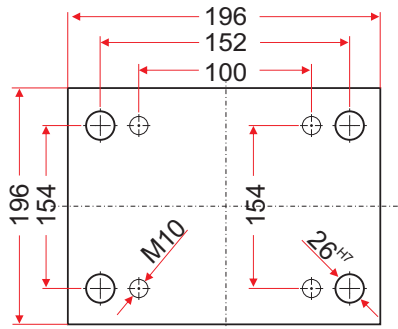

# 196.196

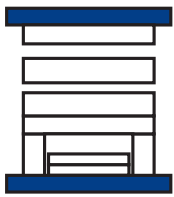

W801

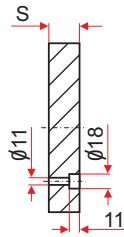
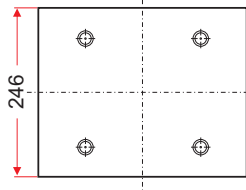

S	22
	27

Material: 1730

W810/K10/F10  
W811/K11/F15

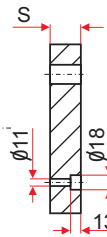
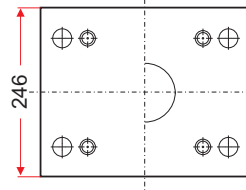

S	22
	27

Material: 1730

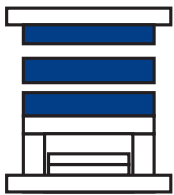

W820/K20/F50

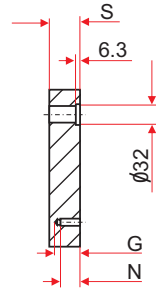
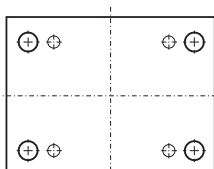

S=22		S>22	
G	20		20
N	15		15

S	Material			
	1.1730	1.2311	1.2738	1.2344
22	*	*	*	
27	*	*	*	*
36	*	*	*	*
46	*	*	*	*
56	*	*	*	
66	*	*	*	
76	*	*	*	
86		*		
96	*	*	*	
116	*	*		

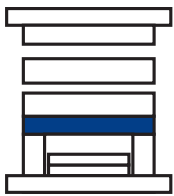

W803

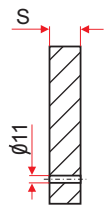
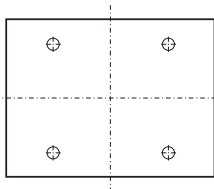

S	27
	36

Material: 1730

W830/K30/F60

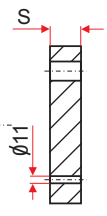
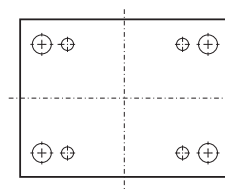

S	27
	36

Material: 1730

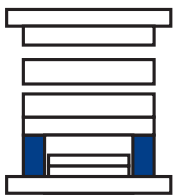

W804

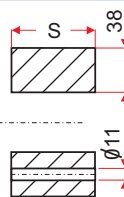
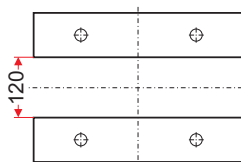

S	46
	56
	76

Material: 1730

W840/K40/F70

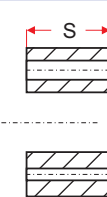
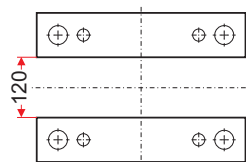

S	46
	56
	66
	76

Material: 1730

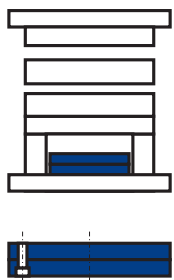

W860/70  
K60/70  
F90

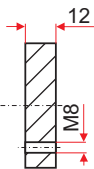
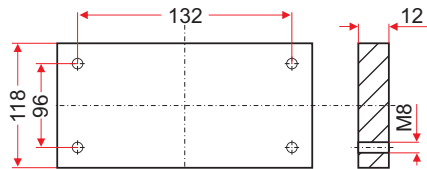

Material	
1.1730	1.2311
*	*

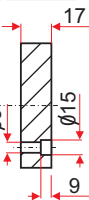
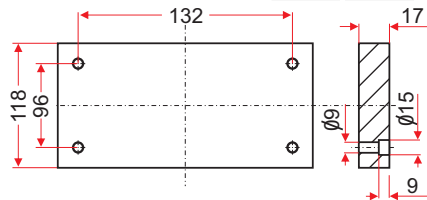

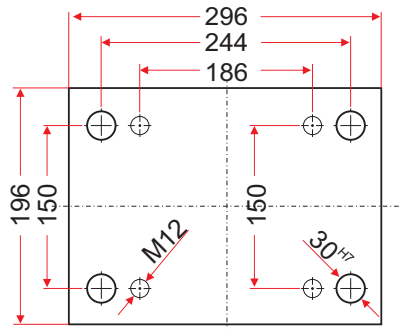

# 196.296



W801

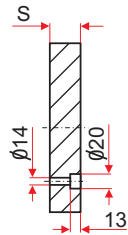
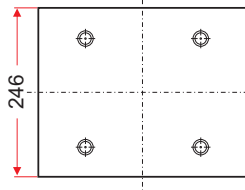

S	27
	36

Material: 1730

W810/K10/F10  
W811/K11/F15

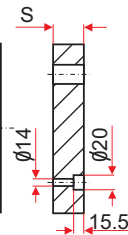
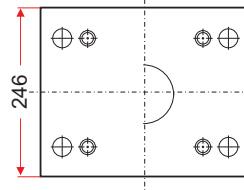

S	27
	36

Material: 1730

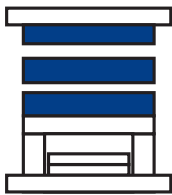

W820/K20/F50

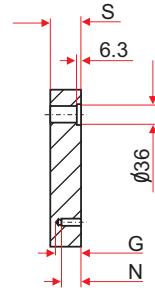
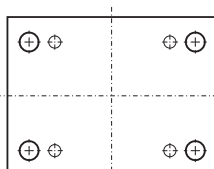

S=22		S>22	
G	20		25
N	15		18

S	Material			
	1.1730	1.2311	1.2738	1.2344
22	*	*	*	
27	*	*	*	*
36	*	*	*	*
46	*	*	*	*
56	*	*	*	
66	*	*	*	
76	*	*	*	
86		*		
96	*	*	*	
116	*	*		

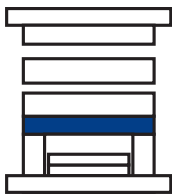

W803

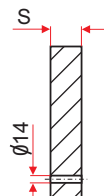
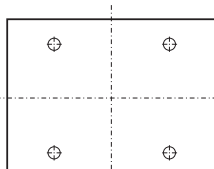

S	22
	36

Material: 1730

W830/K30/F60

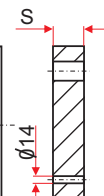
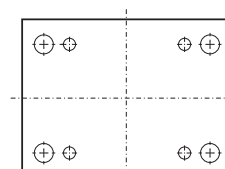

S	22
	36

Material: 1730

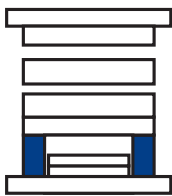

W804

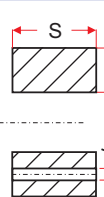
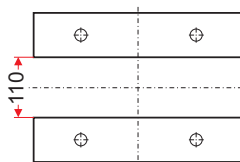

S	56
	76
	96

Material: 1730

W840/K40/F70

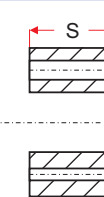
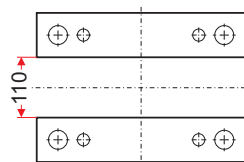

S	56
	66
	76
	86
	96

Material: 1730

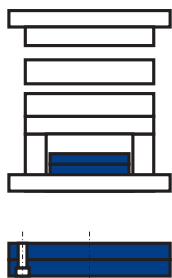

W860/70  
K60/70  
F90

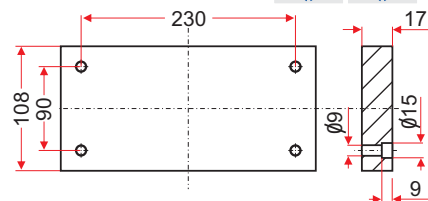
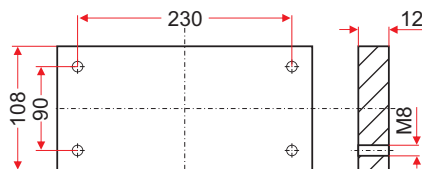

Material	
1.1730	1.2311
*	*

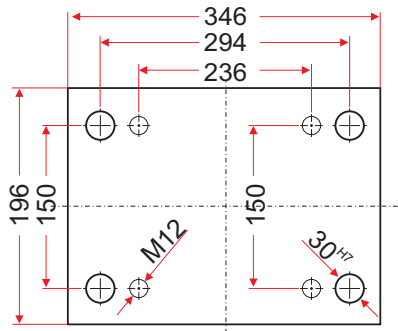

# 196.346

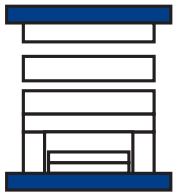

W801

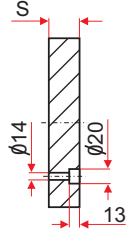
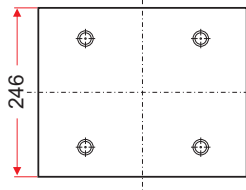

S	27
	36

Material: 1730

W810/K10/F10  
W811/K11/F15

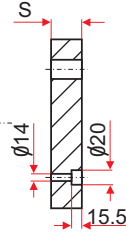
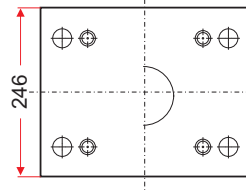

S	27
	36

Material: 1730



W820/K20/F50

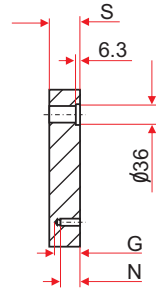
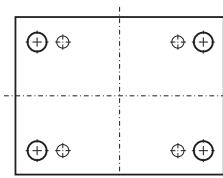

	S=22	S>22
G	20	25
N	15	18

	Material			
	1.1730	1.2311	1.2738	1.2344
S	22	*	*	*
	27	*	*	*
	36	*	*	*
	46	*	*	*
	56	*	*	*
	66	*	*	*
	76	*	*	*
	86		*	
	96	*	*	*
	116	*	*	

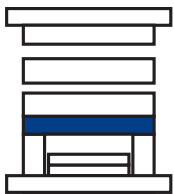

W803

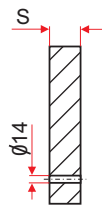
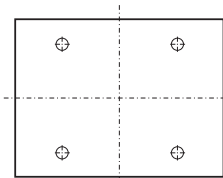

S	36
---	----

Material: 1730

W830/K30/F60

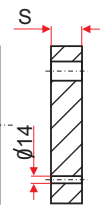
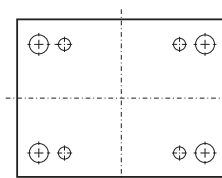

S	36
---	----

Material: 1730

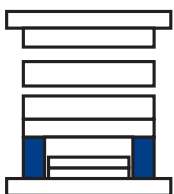

W804

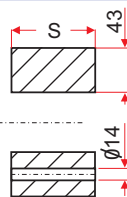
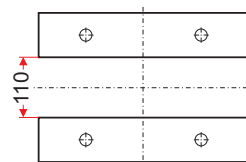

S	56
	76
	96

Material: 1730

W840/K40/F70

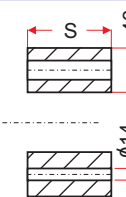
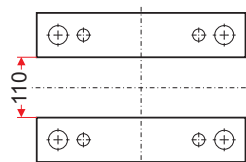

S	56
	66
	76
	86
	96

Material: 1730

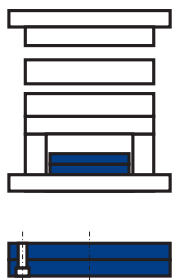

W860/70  
K60/70  
F90

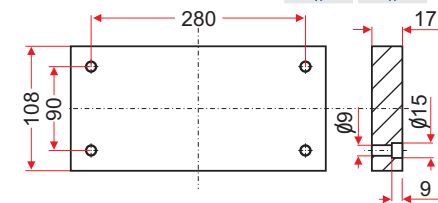
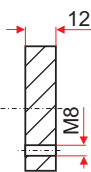
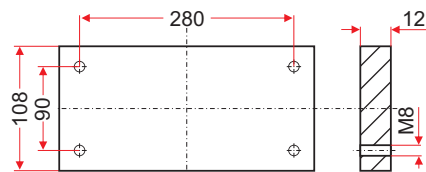

	Material	
	1.1730	1.2311
S	*	*

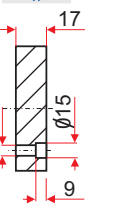



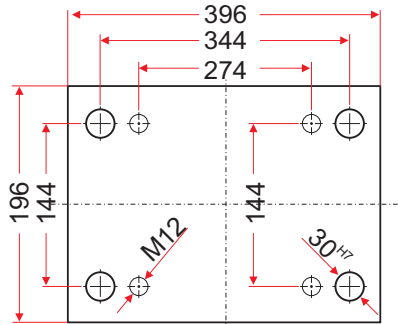

# 196.396



W801

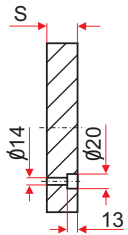
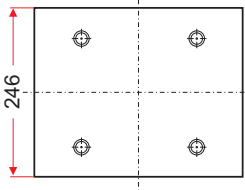

S 27  
36  
Material: 1730

W810/K10/F10  
W811/K11/F15

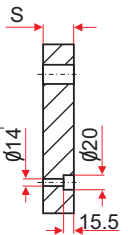
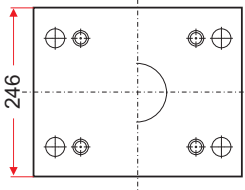

S 27  
36  
Material: 1730



W820/K20/F50

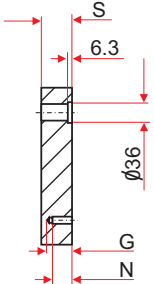
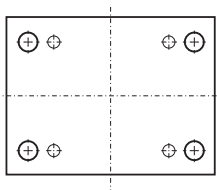

		Material			
		1.1730	1.2311	1.2738	1.2344
S	27	*	*	*	*
	36	*	*	*	*
	46	*	*	*	*
	56	*	*	*	*
	66	*	*	*	
	76	*	*	*	
	86		*		
	96	*	*	*	
S > 22					
G	25				
N	18	*	*		

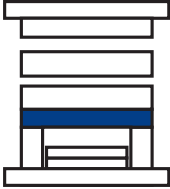

W803

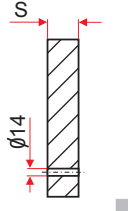
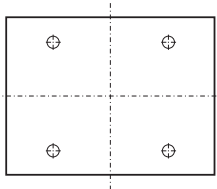

S 36  
Material: 1730

W830/K30/F60

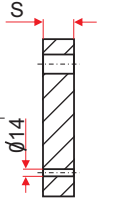
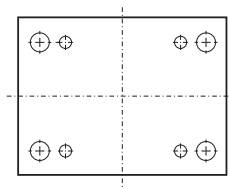

S 36  
Material: 1730

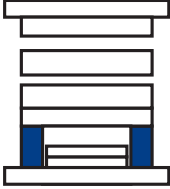

W804

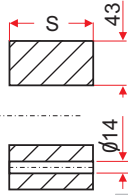
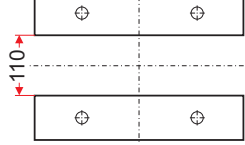

S 56  
76  
96  
Material: 1730

W840/K40/F70

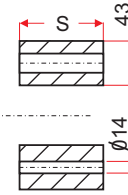
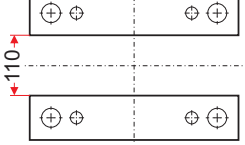

S 56  
66  
76  
86  
96  
Material: 1730

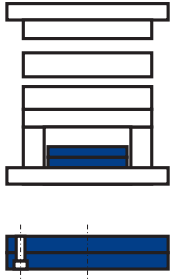

W860/70  
K60/70  
F90

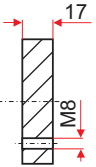
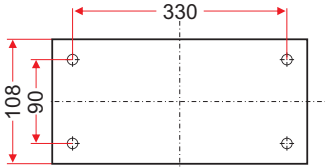

Material: 1730

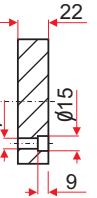
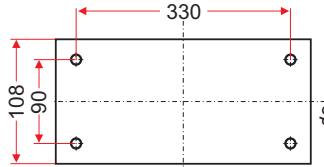

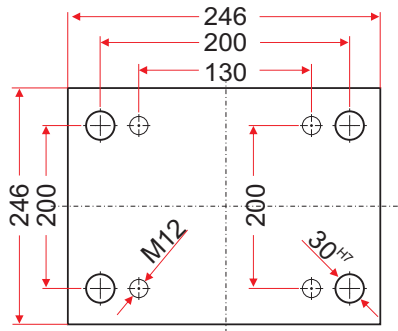

# 246.246

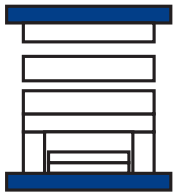

W801

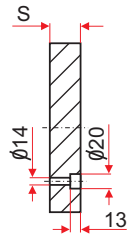
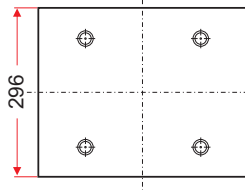

S 27  
36  
Material: 1730

W810/K10/F10  
W811/K11/F15

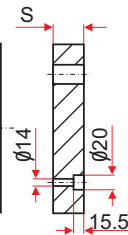
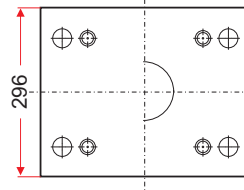

S 27  
36  
Material: 1730



W820/K20/F50

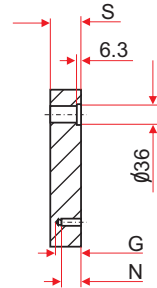
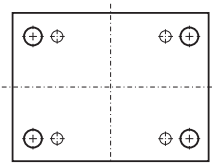

S > 22  
G 25  
N 18

	Material			
	1.1730	1.2311	1.2738	1.2344
S 27	*	*	*	*
S 36	*	*	*	*
S 46	*	*	*	*
S 56	*	*	*	*
S 66	*	*	*	
S 76	*	*	*	
S 86		*		
S 96	*	*	*	
S 116	*	*	*	
S 136	*	*		

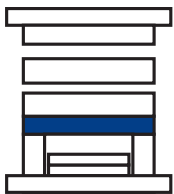

W803

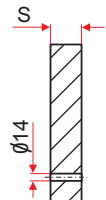
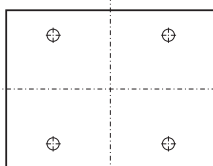

S 27  
36  
Material: 1730

W830/K30/F60

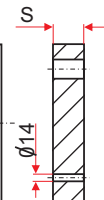
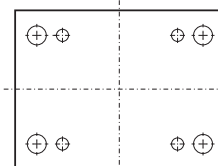

S 27  
36  
Material: 1730

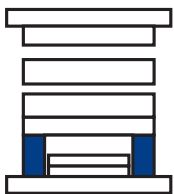

W804

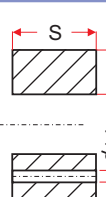
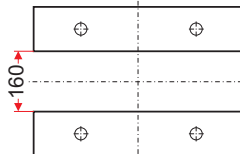

S 56  
76  
96  
Material: 1730

W840/K40/F70

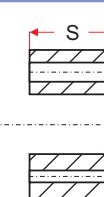

S 56  
66  
76  
86  
96  
Material: 1730

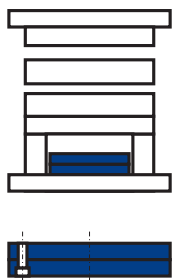

W860/70  
K60/70  
F90

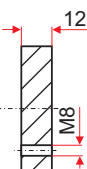
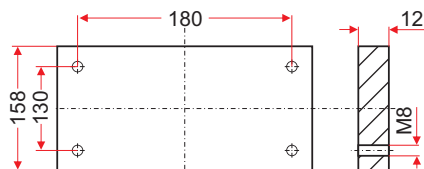

Material	
1.1730	1.2311
*	*

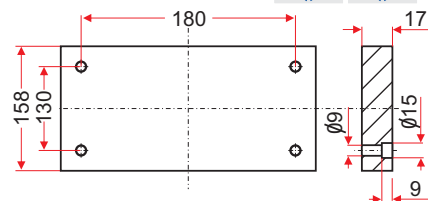

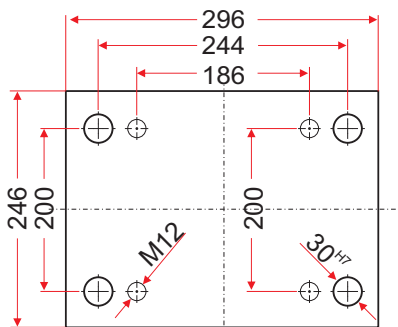

# 246.296



W801

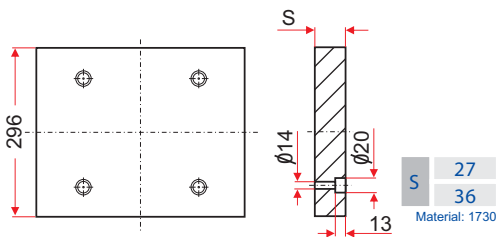

W810/K10/F10  
W811/K11/F15

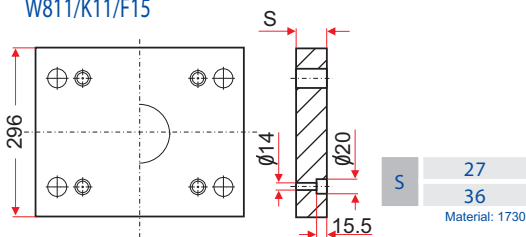

W820/K20/F50

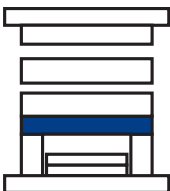
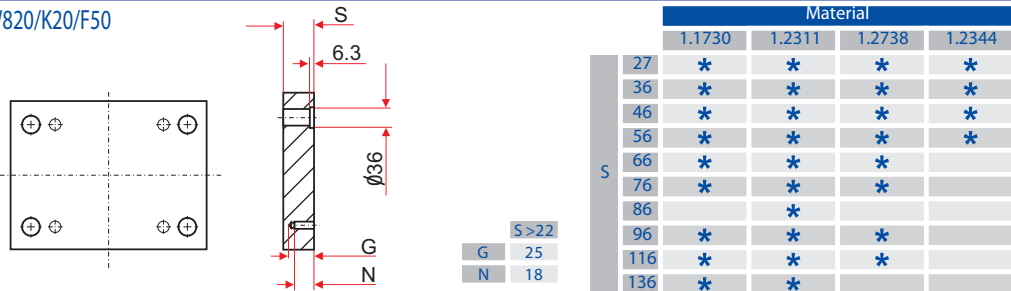

W803

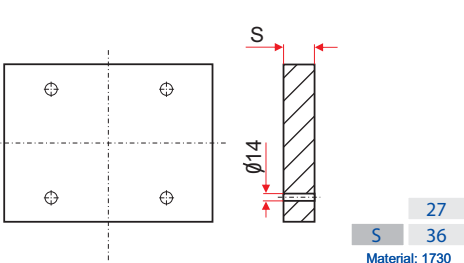

W830/K30/F60

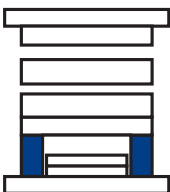
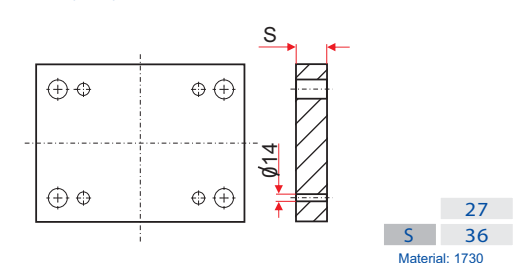

W804

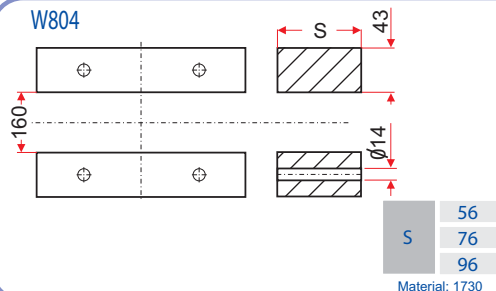

W840/K40/F70

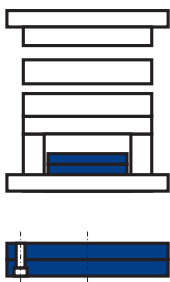
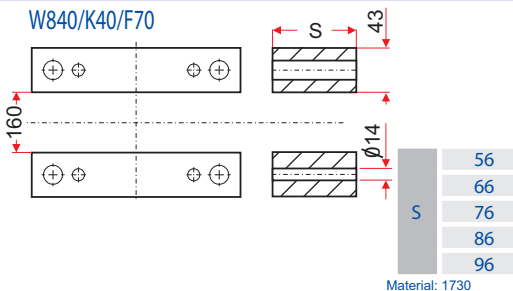

W860/70  
K60/70  
F90

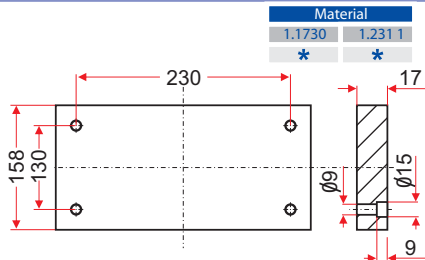
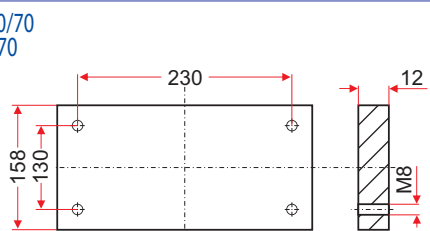

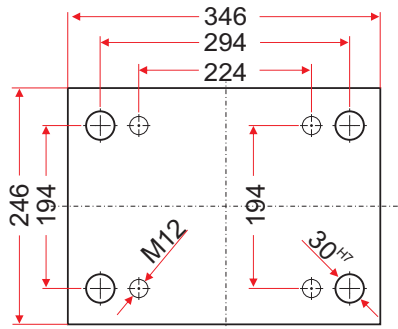

# 246.346

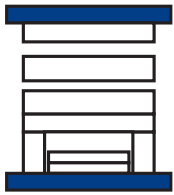

W801

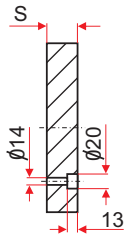
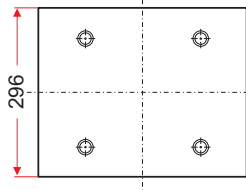

S	27
	36

Material: 1730

W810/K10/F10  
W811/K11/F15

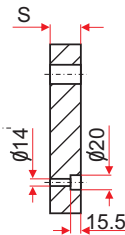
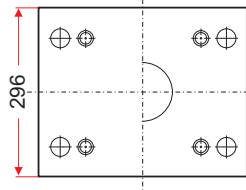

S	27
	36

Material: 1730



W820/K20/F50

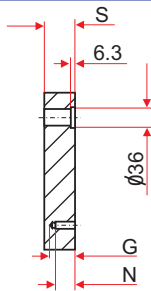
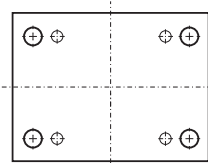

S > 22	
G	25
N	18

	Material			
	1.1730	1.2311	1.2738	1.2344
S	*	*	*	*
27	*	*	*	*
36	*	*	*	*
46	*	*	*	*
56	*	*	*	
66	*	*	*	
76	*	*	*	
86		*		
96	*	*	*	
116	*	*	*	
136	*	*		

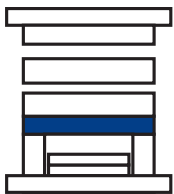

W803

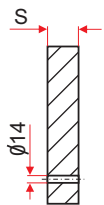
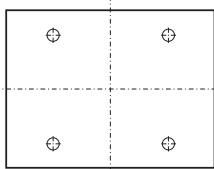

S	27
	36
	46

Material: 1730

W830/K30/F60

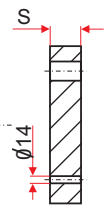
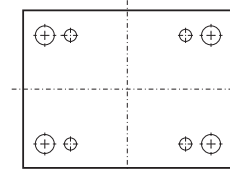

S	27
	36
	46

Material: 1730

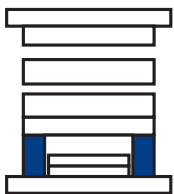

W804

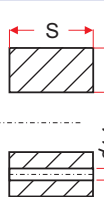
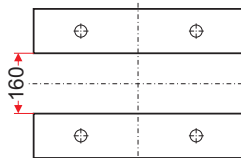

S	56
	76
	96

Material: 1730

W840/K40/F70

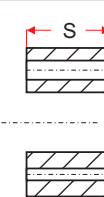
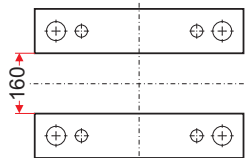

S	56
	66
	76
	86
	96

Material: 1730

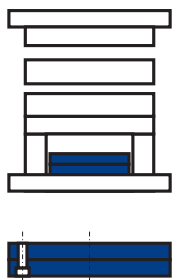

W860/70  
K60/70  
F90

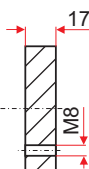
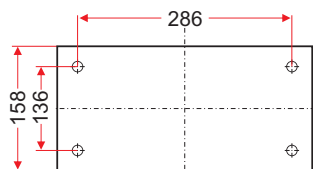

Material	
1.1730	1.2311
*	*

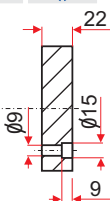
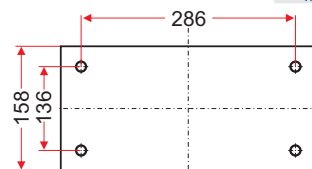

# 246.396

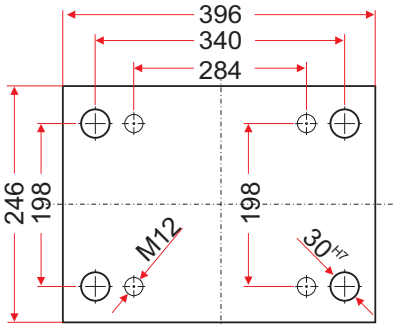

W801

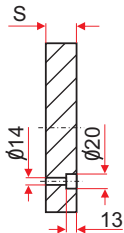
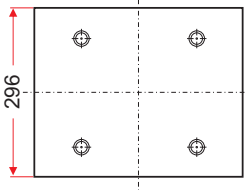

S	27
	36

Material: 1730

W810/K10/F10  
W811/K11/F15

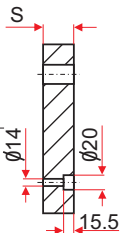
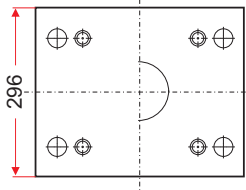

S	27
	36

Material: 1730



W820/K20/F50

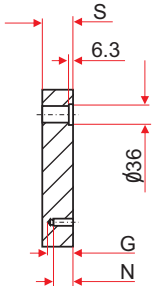
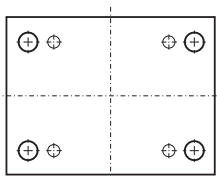

S > 22	
G	25
N	18

	Material			
	1.1730	1.2311	1.2738	1.2344
S	*	*	*	*
27	*	*	*	*
36	*	*	*	*
46	*	*	*	*
56	*	*	*	
66	*	*	*	
76	*	*	*	
86		*		
96	*	*	*	
116	*	*	*	
136	*	*		

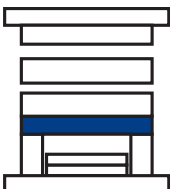

W803

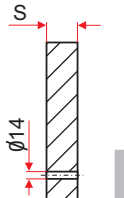
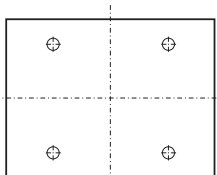

S	27
	36
	46

Material: 1730

W830/K30/F60

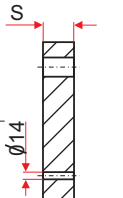
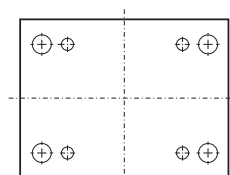

S	27
	36
	46

Material: 1730

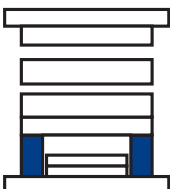

W804

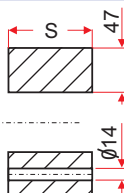
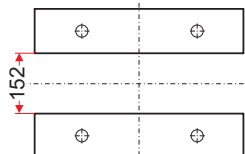

S	56
	76
	96

Material: 1730

W840/K40/F70

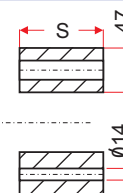
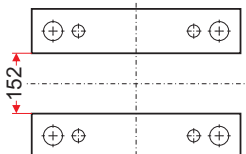

S	56
	66
	76
	86
	96

Material: 1730



W860/70  
K60/70  
F90

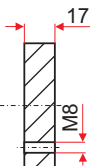
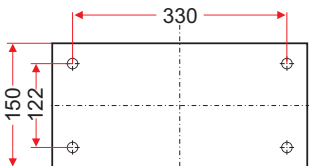

Material: 1730

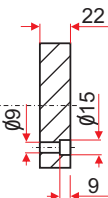
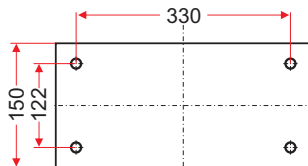

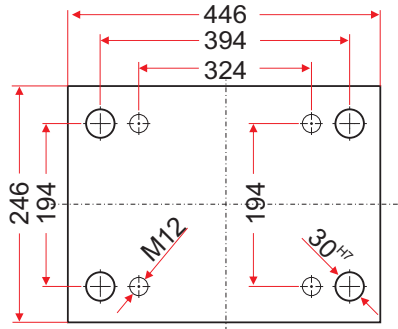

# 246.446

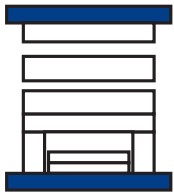

W801

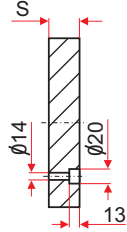
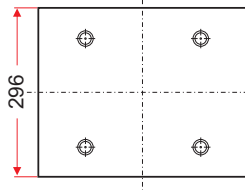

S	27
	36

Material: 1730

W810/K10/F10  
W811/K11/F15

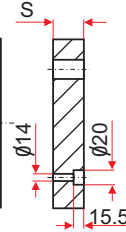
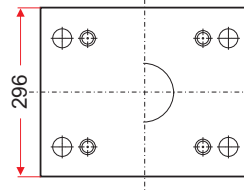

S	27
	36

Material: 1730



W820/K20/F50

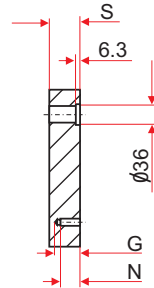
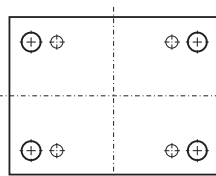

S > 22	
G	25
N	18

Material			
	1.1730	1.2311	1.2738
S	*	*	*
27	*	*	*
36	*	*	*
46	*	*	*
56	*	*	*
66	*	*	*
76	*	*	*
86		*	
96	*	*	*
116	*	*	*
136	*	*	*

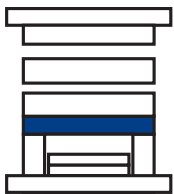

W803

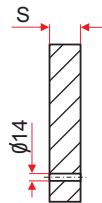
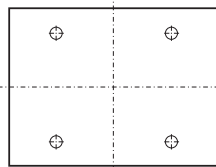

S	27
	36
	46

Material: 1730

W830/K30/F60

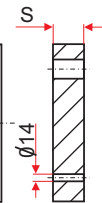
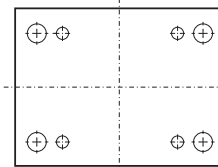

S	27
	36
	46

Material: 1730

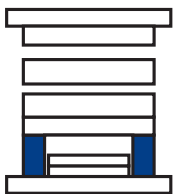

W804

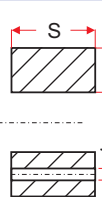
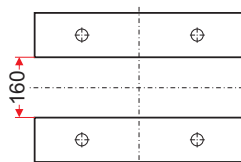

S	56
	76
	96

Material: 1730

W840/K40/F70

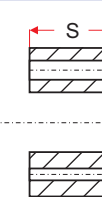
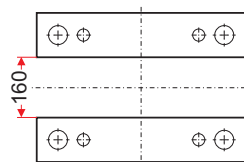

S	56
	66
	76
	86
	96

Material: 1730

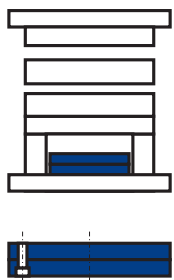

W860/70  
K60/70  
F90

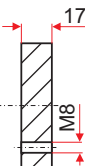
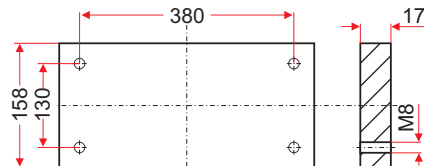

Material: 1730

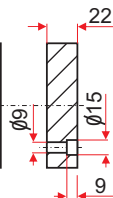
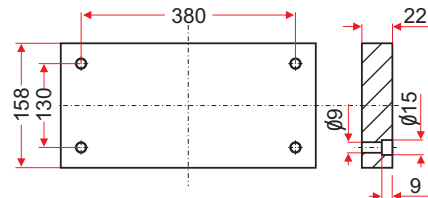

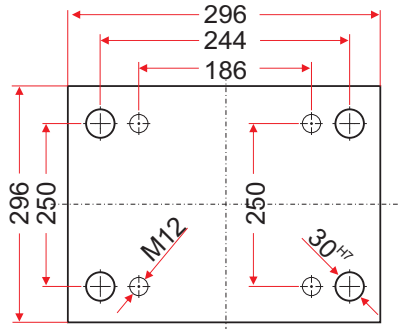

# 296.296

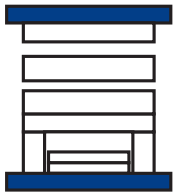

W801

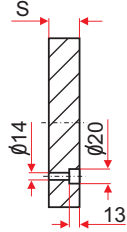
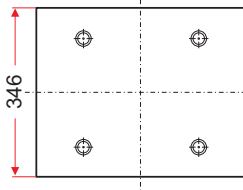

S	27
	36

Material: 1730

W810/K10/F10  
W811/K11/F15

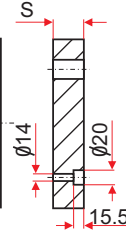
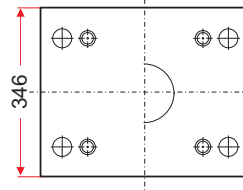

S	27
	36

Material: 1730



W820/K20/F50

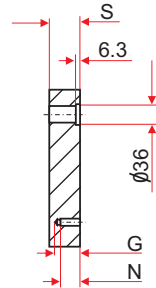
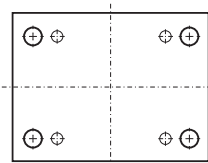

S > 22	
G	25
N	18

	Material			
	1.1730	1.2311	1.2738	1.2344
S	*	*	*	*
27	*	*	*	*
36	*	*	*	*
46	*	*	*	*
56	*	*	*	
66	*	*	*	
76	*	*	*	
86		*		
96	*	*	*	
116	*	*	*	
136	*	*		

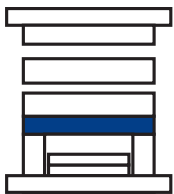

W803

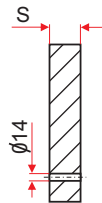
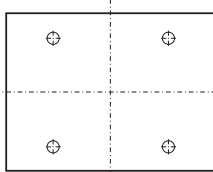

S	27
	36
	46

Material: 1730

W830/K30/F60

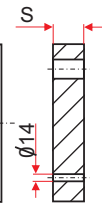
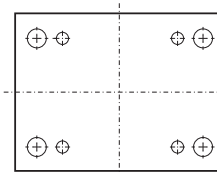

S	27
	36
	46

Material: 1730

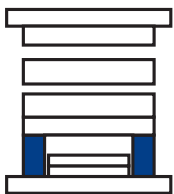

W804

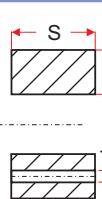
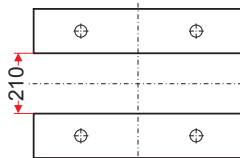

S	56
	76
	96

Material: 1730

W840/K40/F70

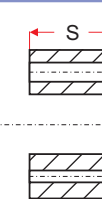
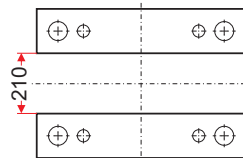

S	56
	66
	76
	86
	96

Material: 1730

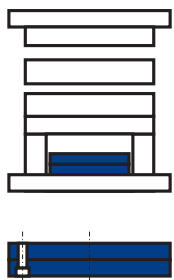

W860/70  
K60/70  
F90

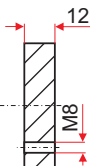
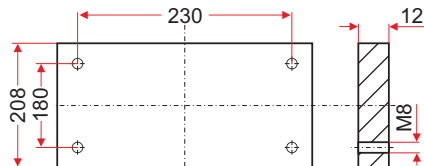

Material	
1.1730	1.2311
*	*

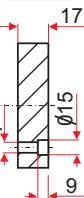
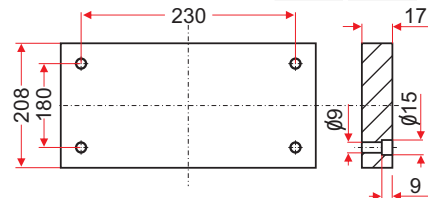

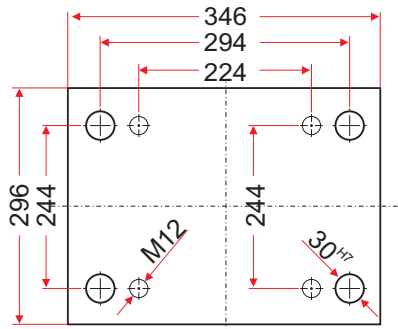

# 296.346

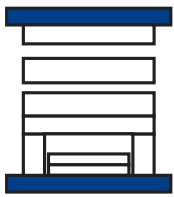

W801

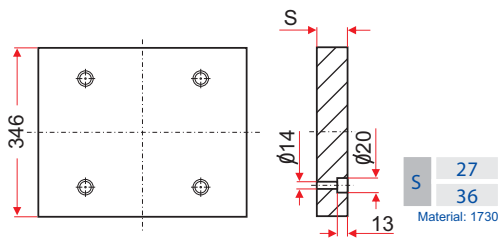

W810/K10/F10  
W811/K11/F15

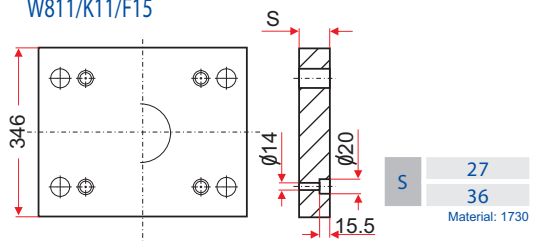

W820/K20/F50

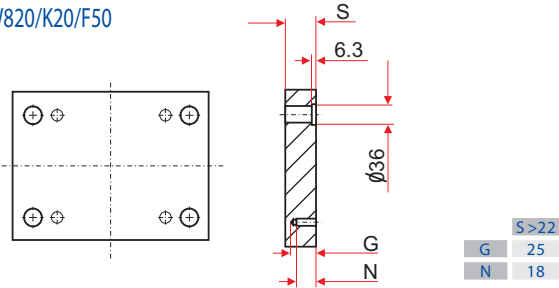

	Material			
	1.1730	1.2311	1.2738	1.2344
S	*	*	*	*
	*	*	*	*
	*	*	*	*
	*	*	*	
	*	*	*	
	*	*	*	
	*	*	*	
	*	*	*	
	*	*	*	
	*	*	*	
	*	*	*	

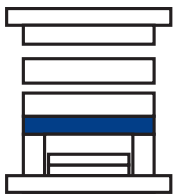

W803

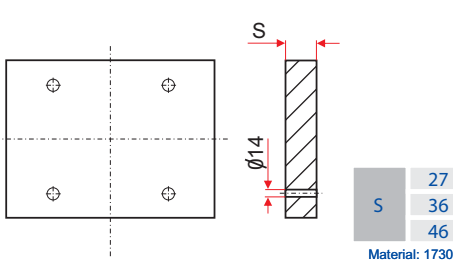

W830/K30/F60

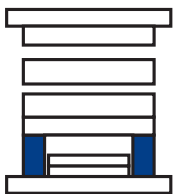
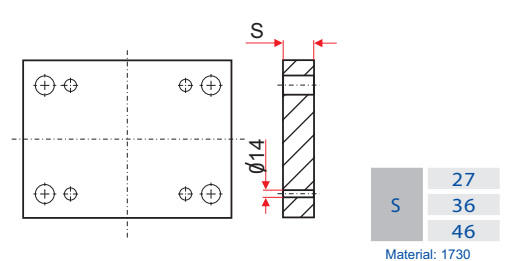

W804

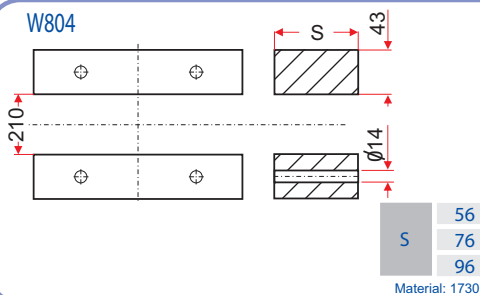

W840/K40/F70

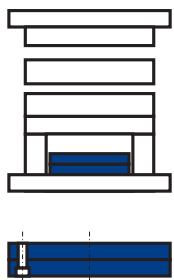
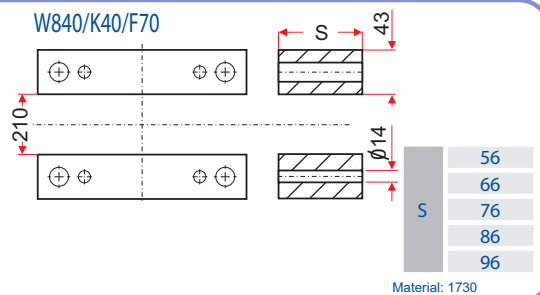

W860/70  
K60/70  
F90

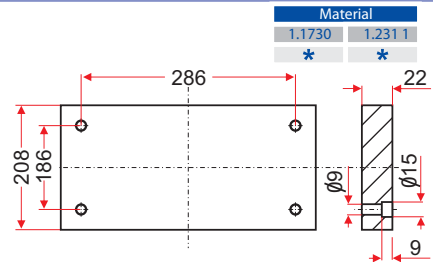
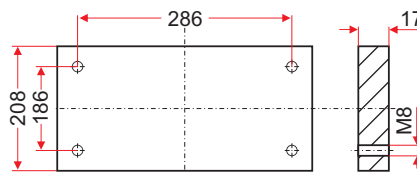



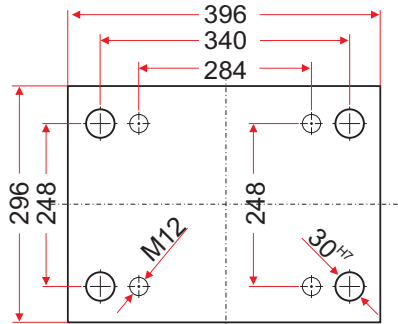

# 296.396



W801

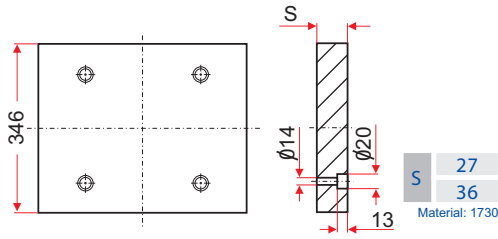

W810/K10/F10  
W811/K11/F15

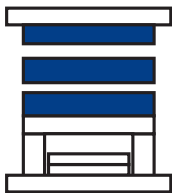
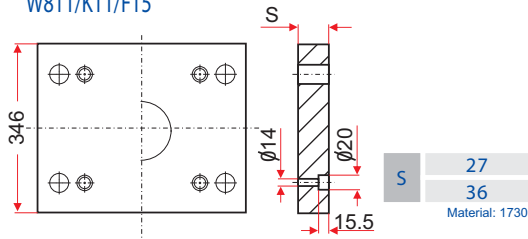

W820/K20/F50

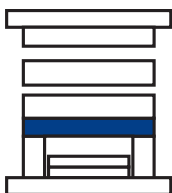
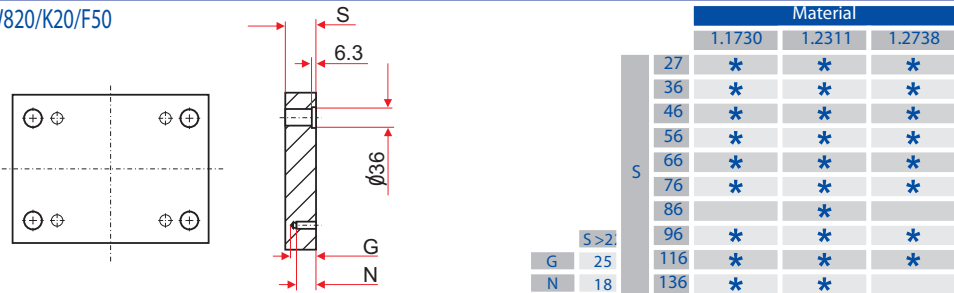

W803

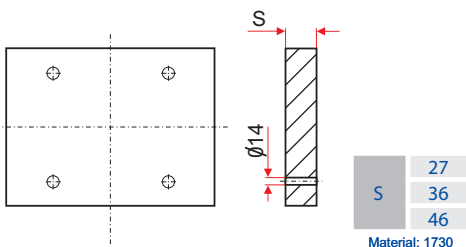

W830/K30/F60

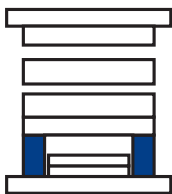
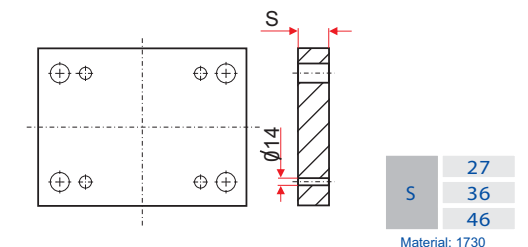

W804

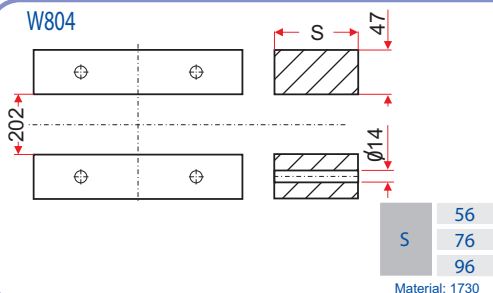

W840/K40/F70

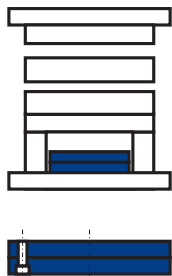
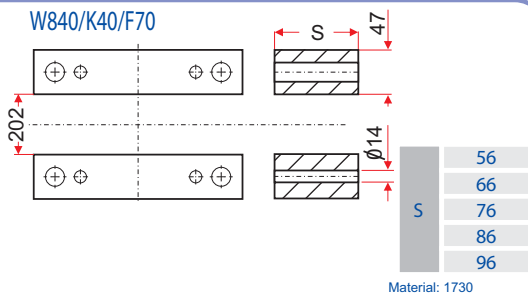

W860/70  
K60/70  
F90

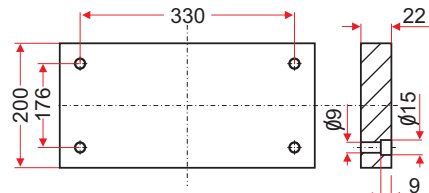
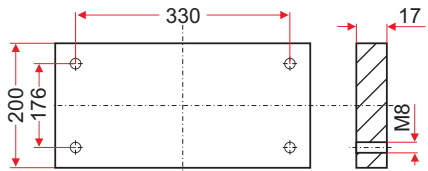



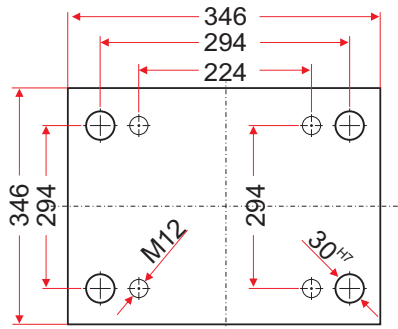

# 346.346

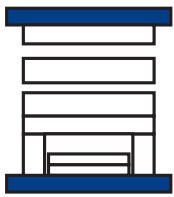

W801

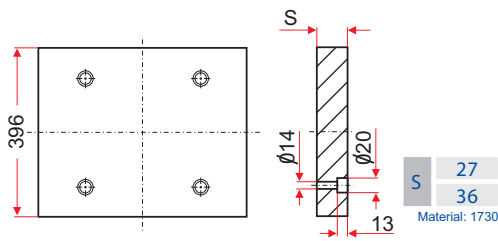

W810/K10/F10  
W811/K11/F15

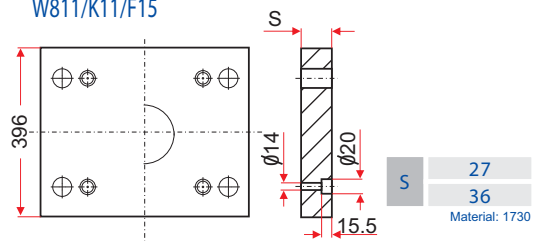

W820/K20/F50

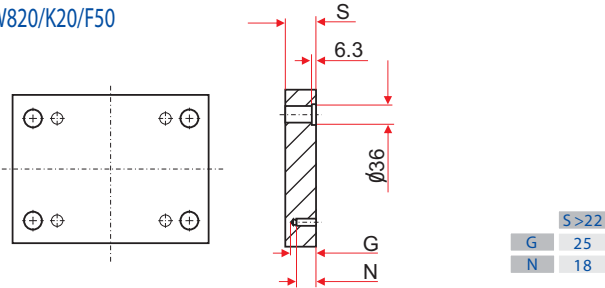

	Material		
	1.1730	1.2311	1.2738
S	*	*	*
36	*	*	*
46	*	*	*
56	*	*	*
66	*	*	*
76	*	*	*
86		*	
96	*	*	*
116	*	*	*
136	*	*	*

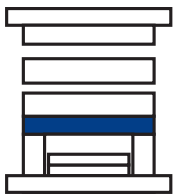

W803

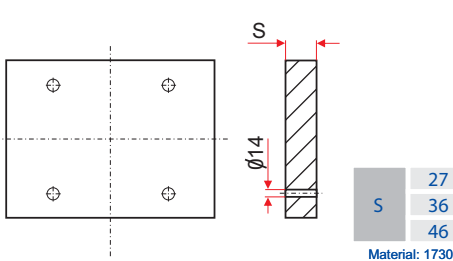

W830/K30/F60

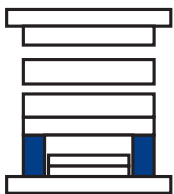
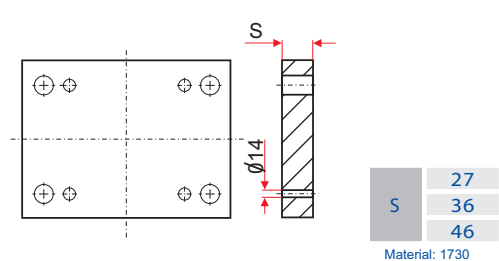

W804

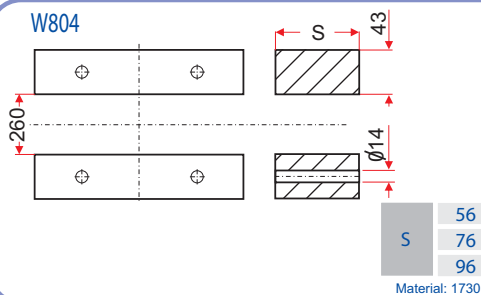

W840/K40/F70

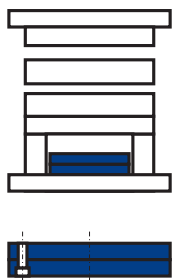
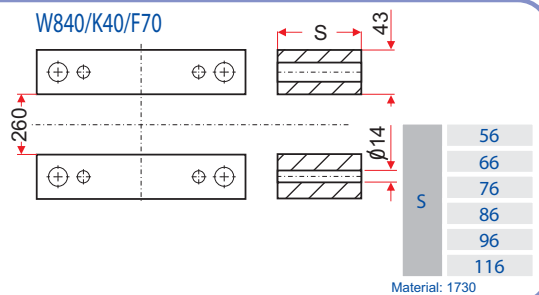

W860/70  
K60/70  
F90

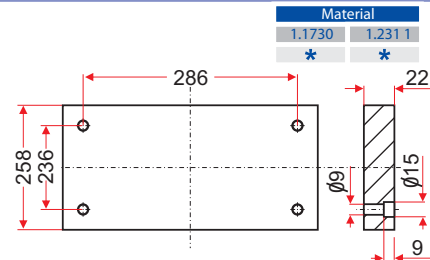
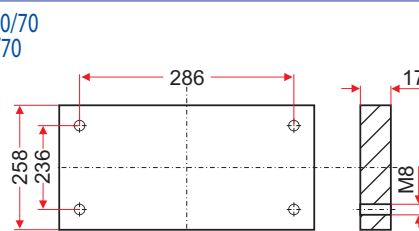

	Material	
	1.1730	1.2311
S	*	*

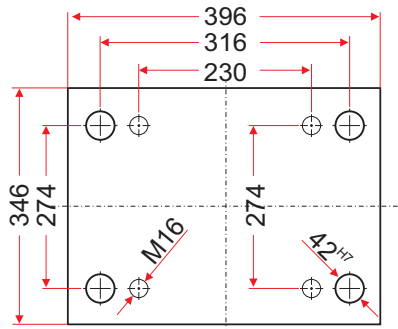

# 346.396

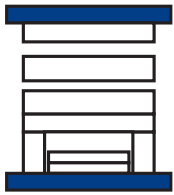

W801

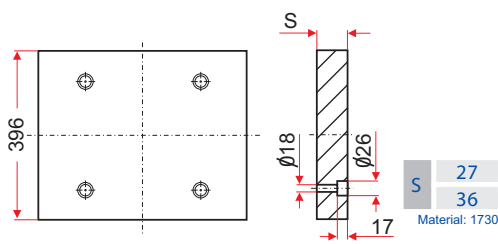

W810/K10/F10  
W811/K11/F15

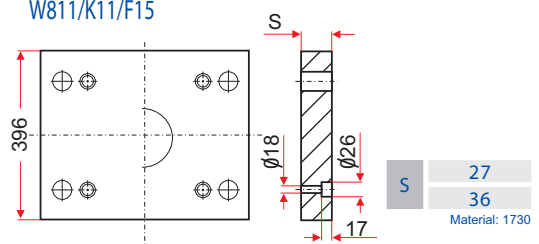

W820/K20/F50

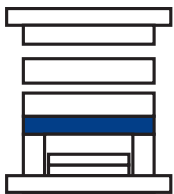
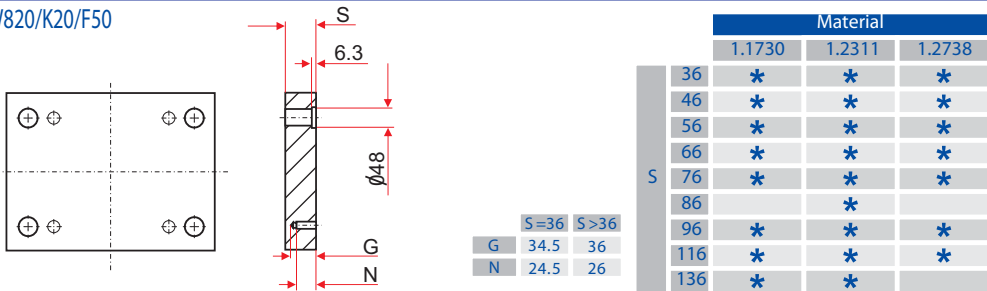

W803

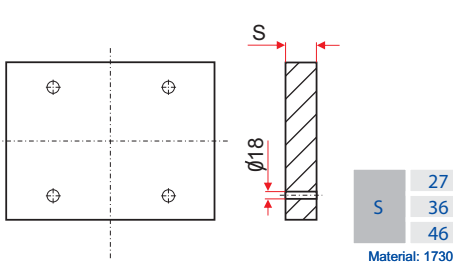

W830/K30/F60

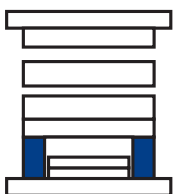
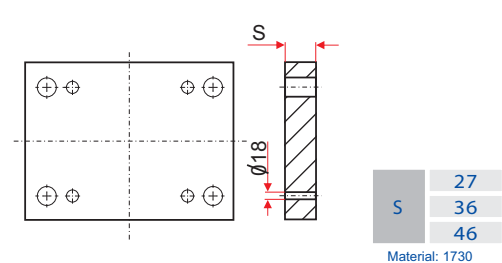

W804

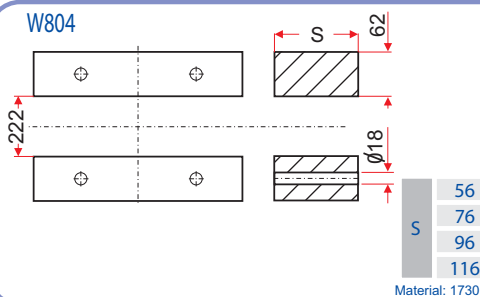

W840/K40/F70

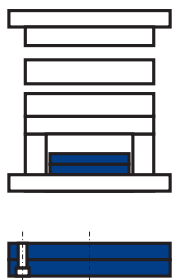
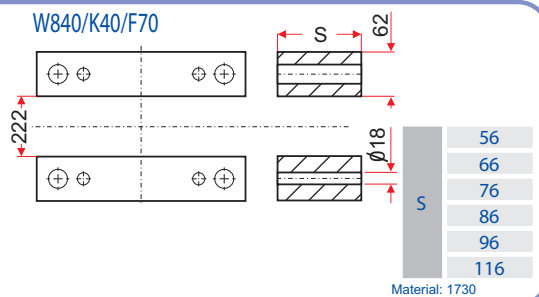

W860/70  
K60/70  
F90

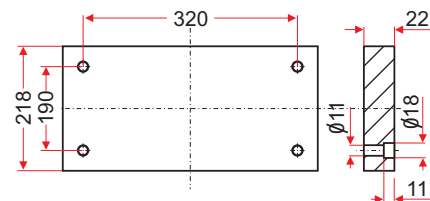
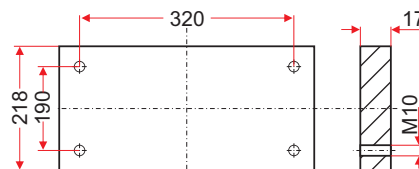

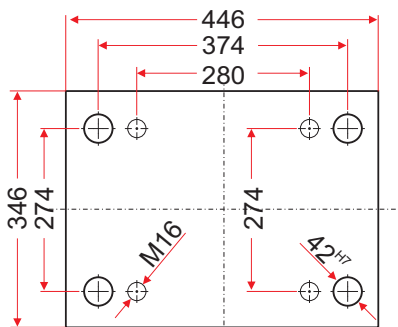

# 346.446



W801

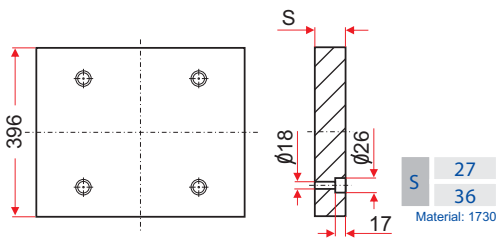

W810/K10/F10  
W811/K11/F15

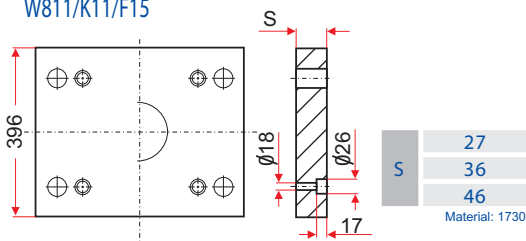

W820/K20/F50

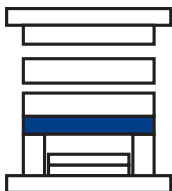
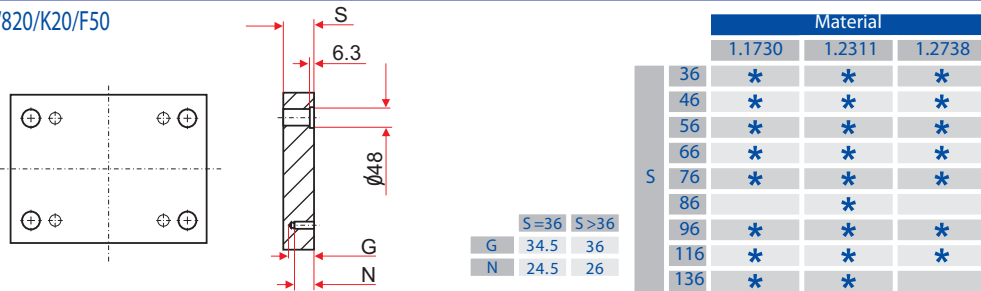

W803

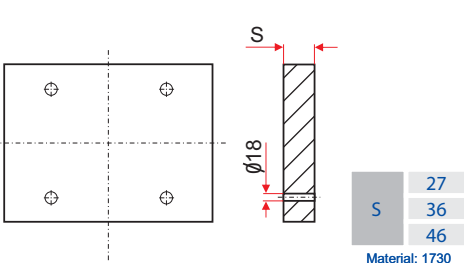

W830/K30/F60

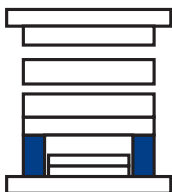
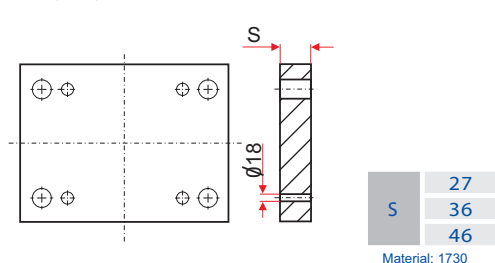

W804

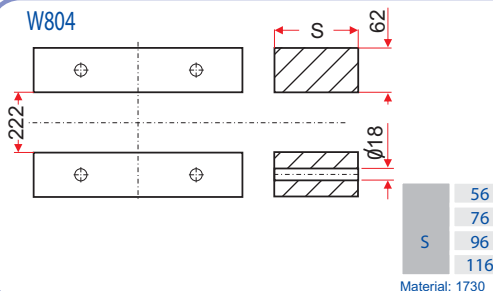

W840/K40/F70

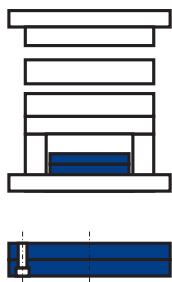
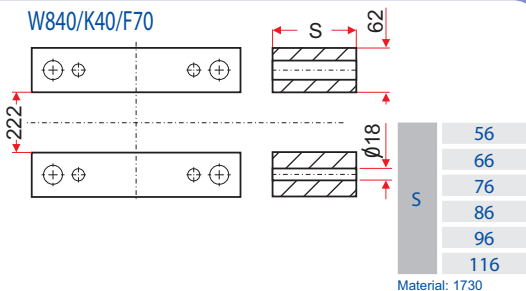

W860/70  
K60/70  
F90

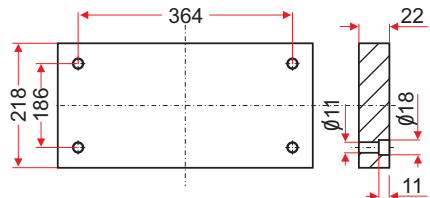
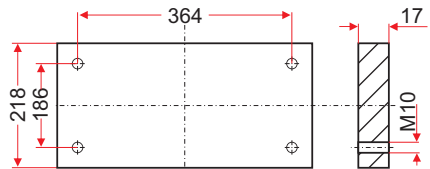

Material: 1730

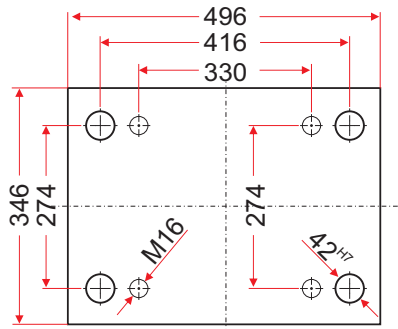

# 346.496

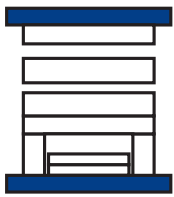

W801

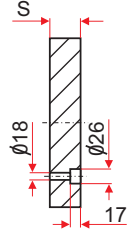
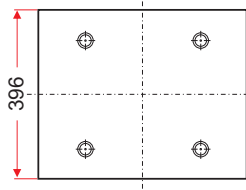

S	27
S	36
S	46

Material: 1730

W810/K10/F10  
W811/K11/F15

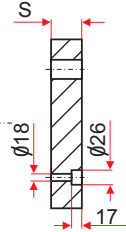
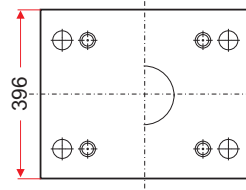

S	27
S	36
S	46

Material: 1730

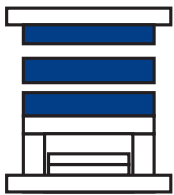

W820/K20/F50

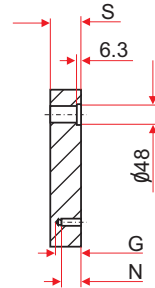
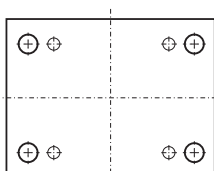

G	34.5	36
N	24.5	26

		Material		
		1.1730	1.2311	1.2738
S	36	*	*	*
	46	*	*	*
	56	*	*	*
	66	*	*	*
	76	*	*	*
	86		*	
	96	*	*	*
	116	*	*	*
	136	*	*	*

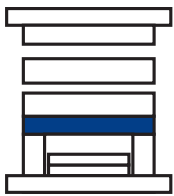

W803

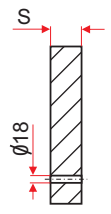
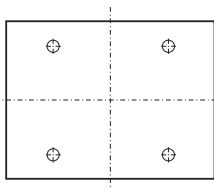

S	36
S	46

Material: 1730

W830/K30/F60

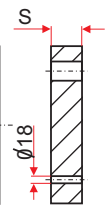
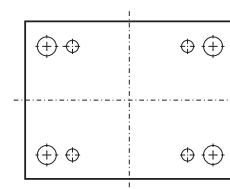

S	36
S	46

Material: 1730

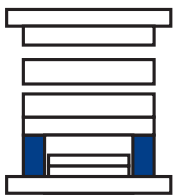

W804

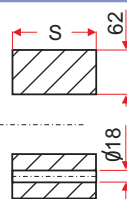
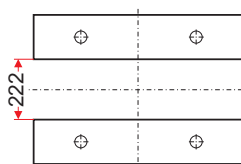

S	56
S	76
S	96
S	116

Material: 1730

W840/K40/F70

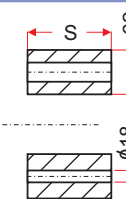
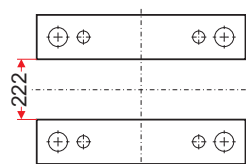

S	56
S	66
S	76
S	86
S	96
S	116

Material: 1730

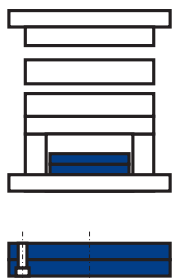

W860/70  
K60/70  
F90

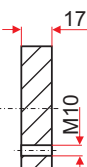
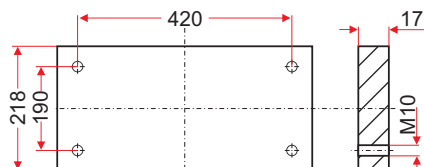

Material: 1730

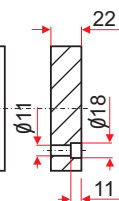
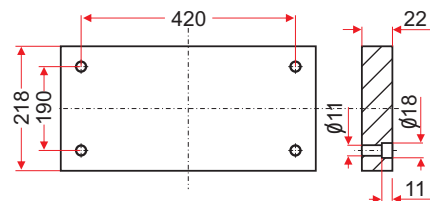

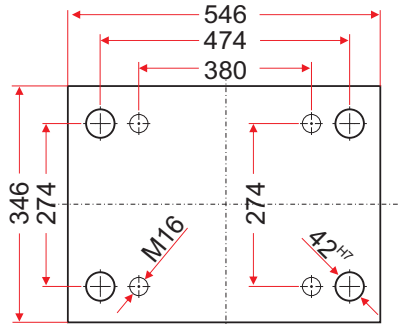

# 346.546



W801

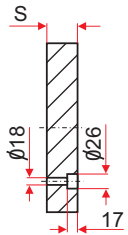
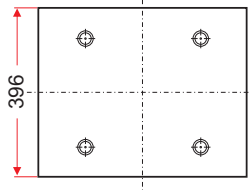

S	36
	46

Material: 1730

W810/K10/F10  
W811/K11/F15

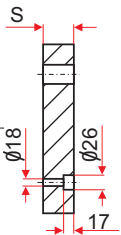
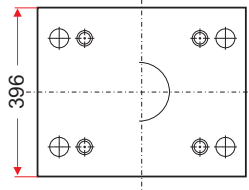

S	36
	46

Material: 1730



W820/K20/F50

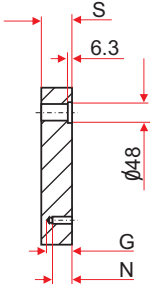
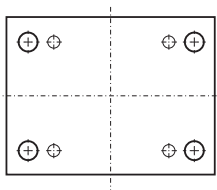

	S=36	S>36
G	34.5	36
N	24.5	26

	Material		
	1.1730	1.2311	1.2738
S 36	*	*	*
S 46	*	*	*
S 56	*	*	*
S 66	*	*	*
S 76	*	*	*
S 86		*	
S 96	*	*	*
S 116	*	*	*
S 136	*	*	*

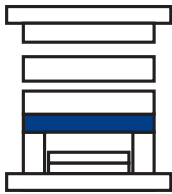

W803

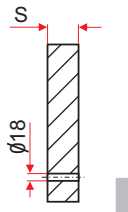
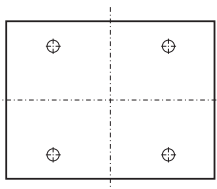

S	36
	46

Material: 1730

W830/K30/F60

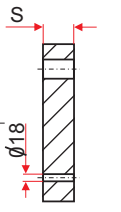
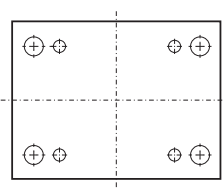

S	36
	46

Material: 1730

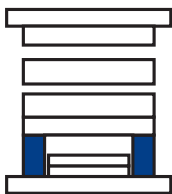

W804

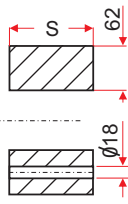
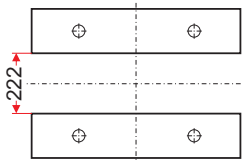

S	56
	76
	96
	116

Material: 1730

W840/K40/F70

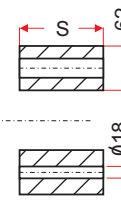
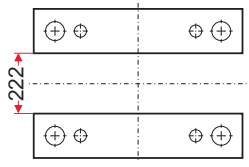

S	56
	66
	76
	86
	96
	116

Material: 1730

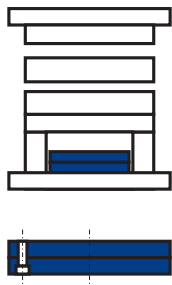

W860/70  
K60/70  
F90

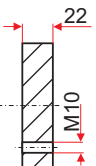
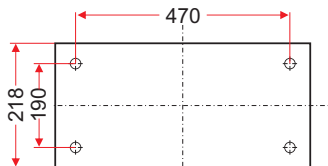

Material: 1730

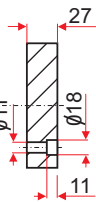
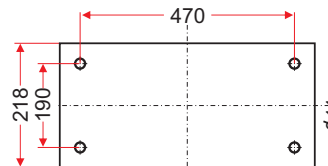

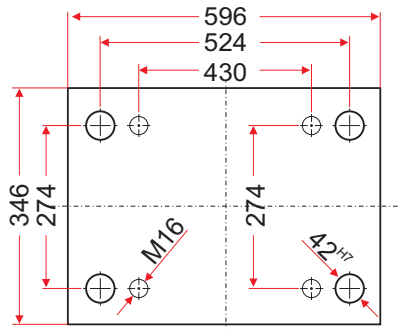

# 346.596

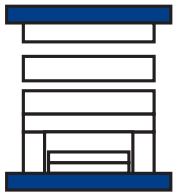

W801

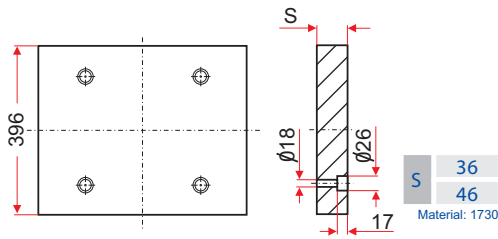

W810/K10/F10  
W811/K11/F15

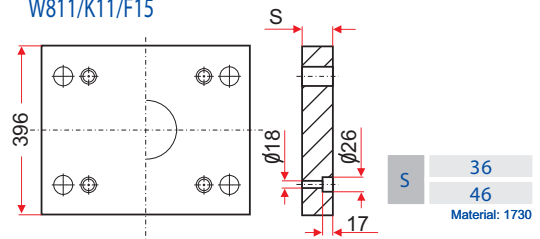

W820/K20/F50

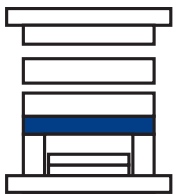
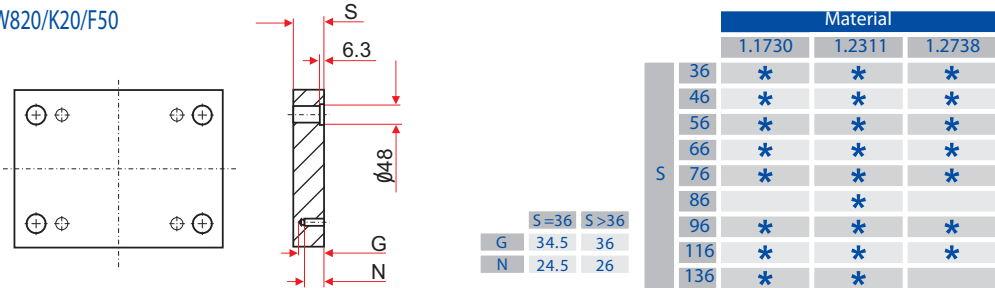

W803

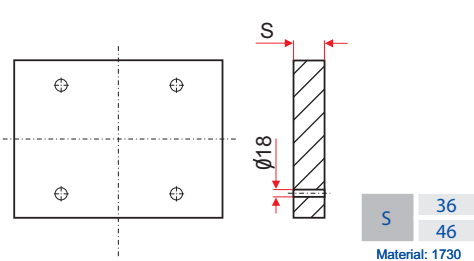

W830/K30/F60

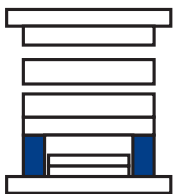
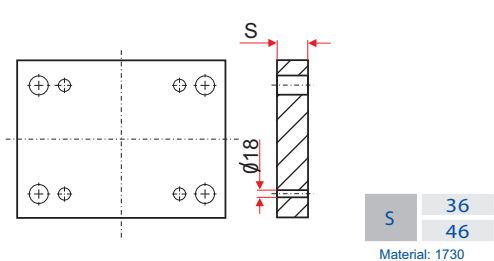

W804

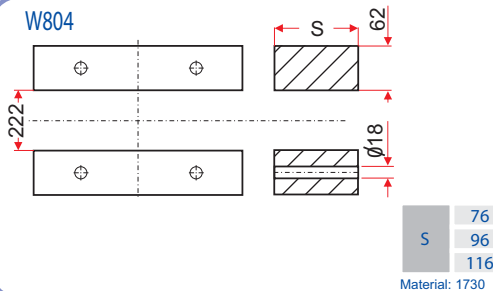

W840/K40/F70

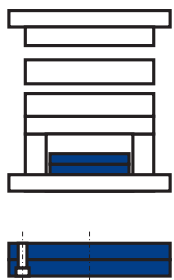
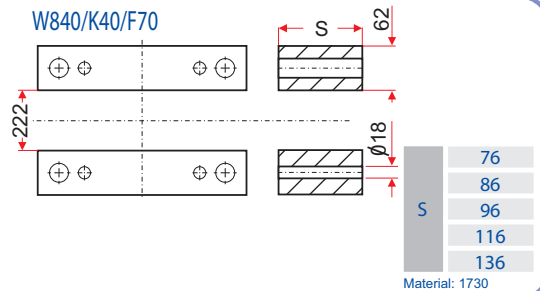

W860/70  
K60/70  
F90

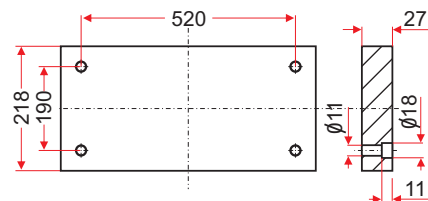
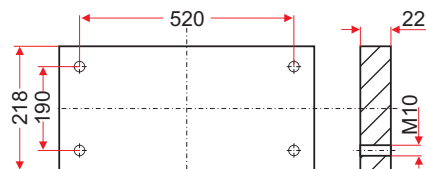



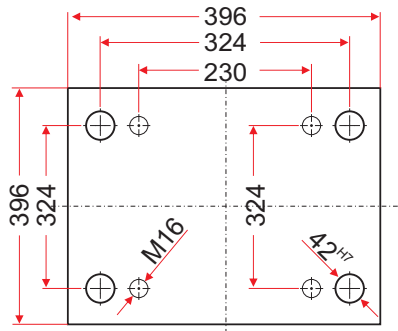

# 396.396

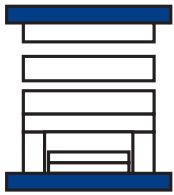

W801

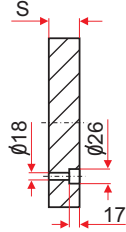
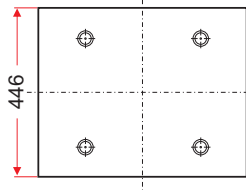

S	27
S	36
S	46

Material: 1730

W810/K10/F10  
W811/K11/F15

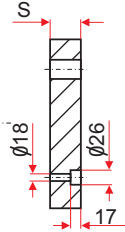
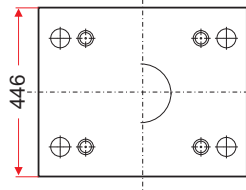

S	27
S	36
S	46

Material: 1730



W820/K20/F50

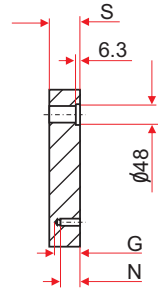
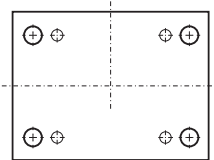

G	34.5	36
N	24.5	26

		Material		
		1.1730	1.2311	1.2738
S	36	*	*	*
	46	*	*	*
	56	*	*	*
	66	*	*	*
	76	*	*	*
	86		*	
	96	*	*	*
	116	*	*	*
	136	*	*	*

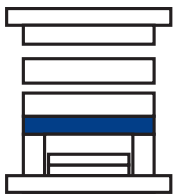

W803

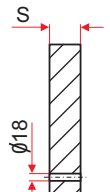
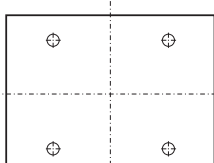

S	36
S	46

Material: 1730

W830/K30/F60

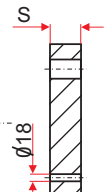
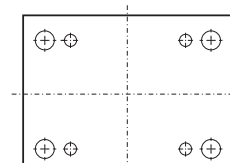

S	36
S	46

Material: 1730

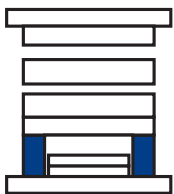

W804

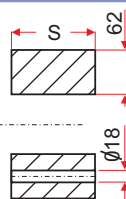
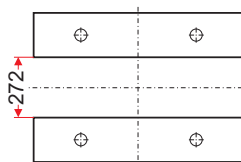

S	56
S	76
S	96
S	116

Material: 1730

W840/K40/F70

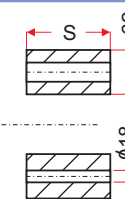
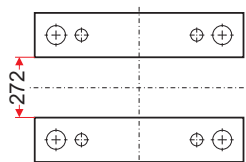

S	56
S	66
S	76
S	86
S	96
S	116

Material: 1730

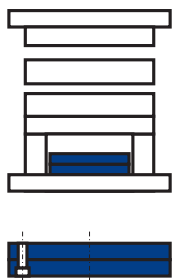

W860/70  
K60/70  
F90

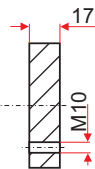
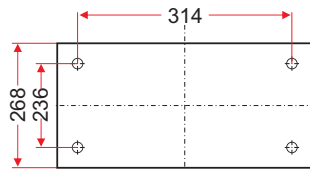

Material: 1730

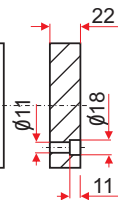
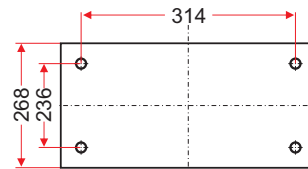

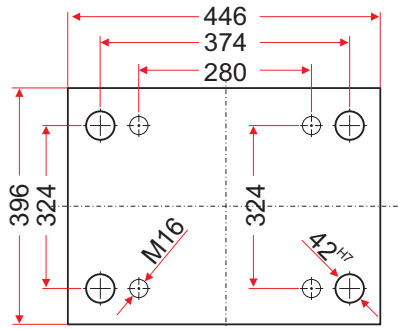

# 396.446

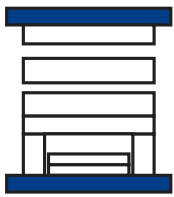

W801

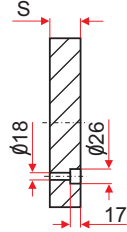
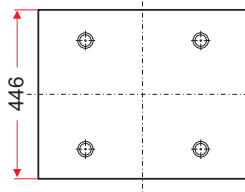

S	27
S	36
S	46

Material: 1730

W810/K10/F10  
W811/K11/F15

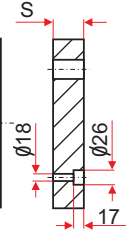
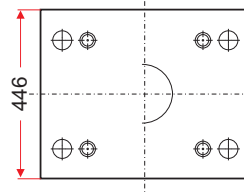

S	27
S	36
S	46

Material: 1730

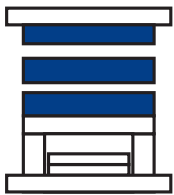

W820/K20/F50

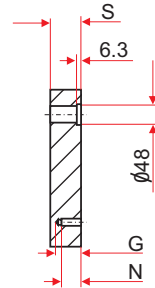
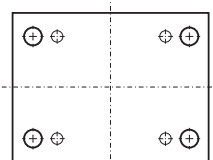

G	S=36	S>36
N	34.5	36
N	24.5	26

Material	Material		
	1.1730	1.2311	1.2738
S 36	*	*	*
S 46	*	*	*
S 56	*	*	*
S 66	*	*	*
S 76	*	*	*
S 86		*	
S 96	*	*	*
S 116	*	*	*
S 136	*	*	*

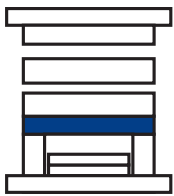

W803

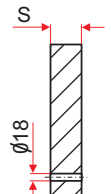
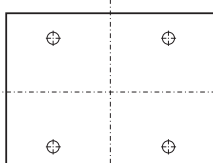

S	36
S	46

Material: 1730

W830/K30/F60

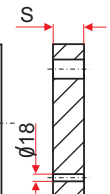
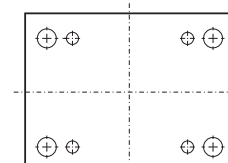

S	36
S	46

Material: 1730

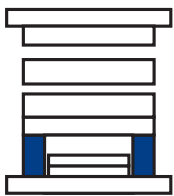

W804

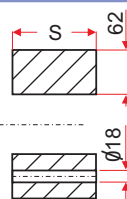
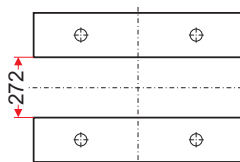

S	56
S	76
S	96
S	116

Material: 1730

W840/K40/F70

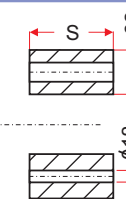
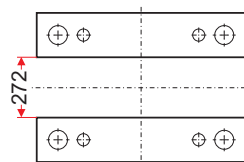

S	56
S	66
S	76
S	86
S	96
S	116

Material: 1730

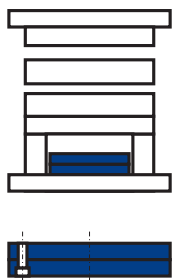

W860/70  
K60/70  
F90

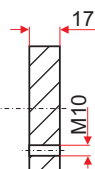
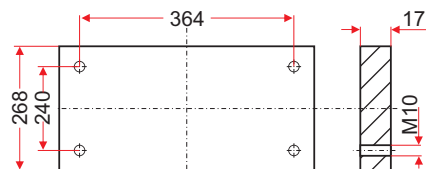

Material: 1730

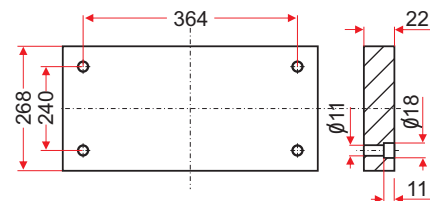

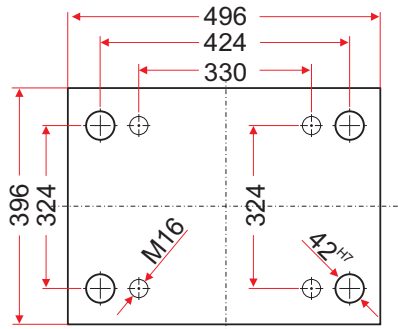

# 396.496

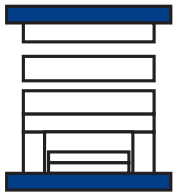

W801

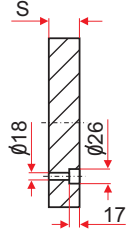
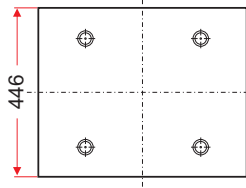

S	36
	46

Material: 1730

W810/K10/F10  
W811/K11/F15

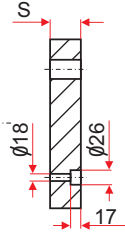
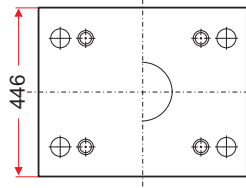

S	36
	46

Material: 1730



W820/K20/F50

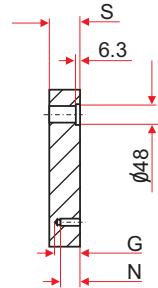
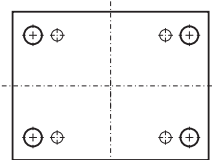

	S=36	S>36
G	34.5	36
N	24.5	26

S	Material		
	1.1730	1.2311	1.2738
36	*	*	*
46	*	*	*
56	*	*	*
66	*	*	*
76	*	*	*
86	*	*	*
96	*	*	*
116	*	*	*
136	*	*	*
156	*	*	*

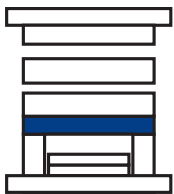

W803

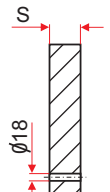
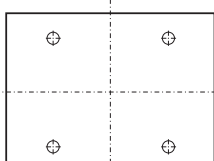

S	36
	46

Material: 1730

W830/K30/F60

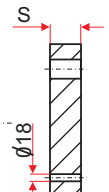
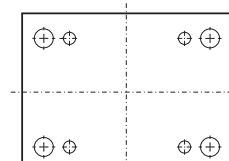

S	36
	46

Material: 1730

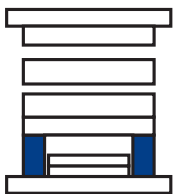

W804

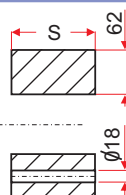
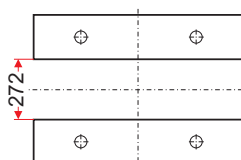

S	76
	96
	116

Material: 1730

W840/K40/F70

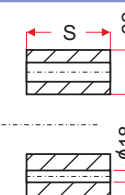
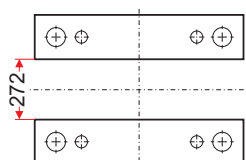

S	76
	86
	96
	116
	136

Material: 1730



W860/70  
K60/70  
F90

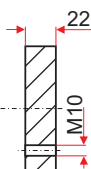
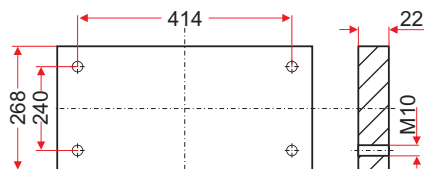

Material: 1730

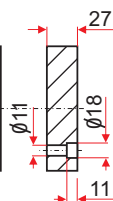
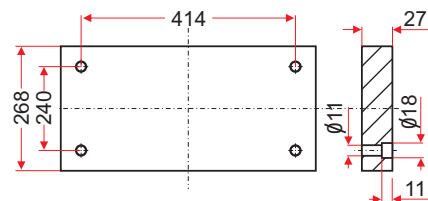

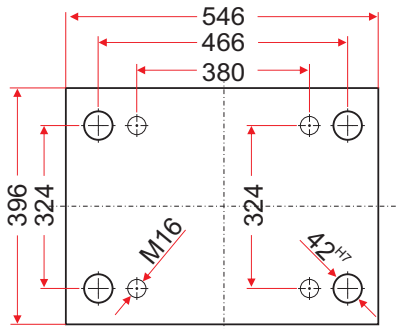

# 396.546

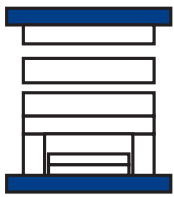

W801

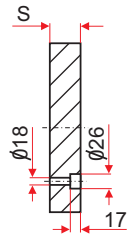
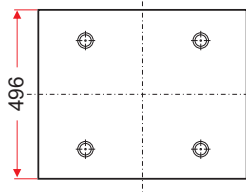

S	36
	46

Material: 1730

W810/K10/F10  
W811/K11/F15

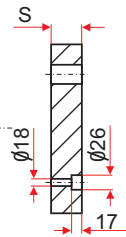
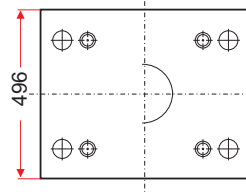

S	36
	46

Material: 1730



W820/K20/F50

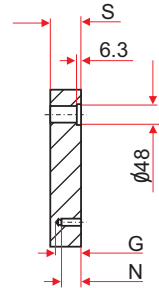
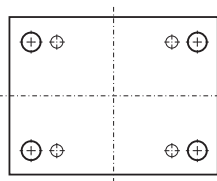

	S=36	S>36
G	34.5	36
N	24.5	26

S	Material		
	1.1730	1.2311	1.2738
36	*	*	*
46	*	*	*
56	*	*	*
66	*	*	*
76	*	*	*
86	*	*	*
96	*	*	*
116	*	*	*
136	*	*	*
156	*	*	*

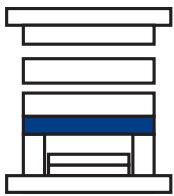

W803

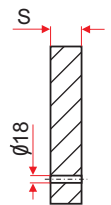
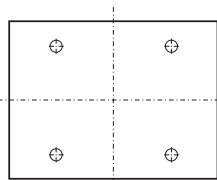

S	36
	46

Material: 1730

W830/K30/F60

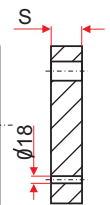
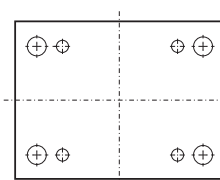

S	36
	46

Material: 1730

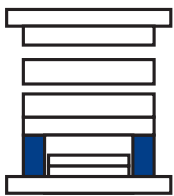

W804

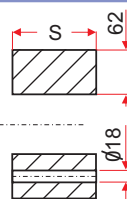
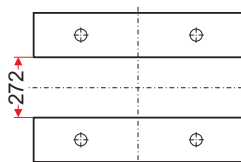

S	76
	96
	116

Material: 1730

W840/K40/F70

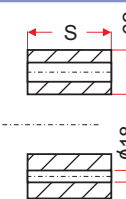
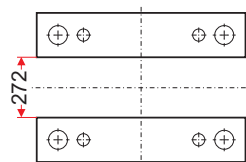

S	76
	86
	96
	116

Material: 1730

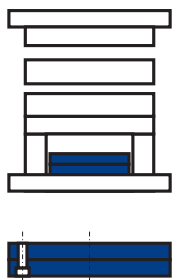

W860/70  
K60/70  
F90

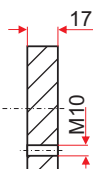
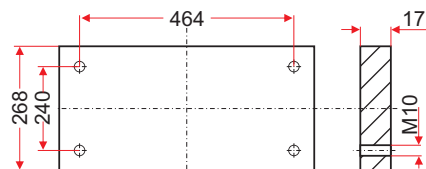

Material: 1730

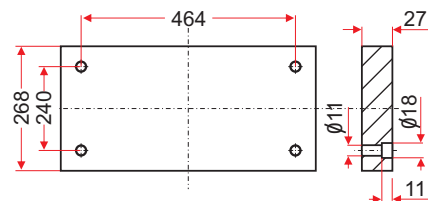

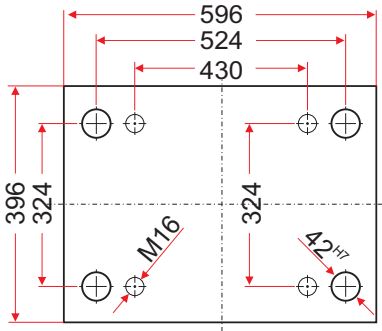

# 396.596

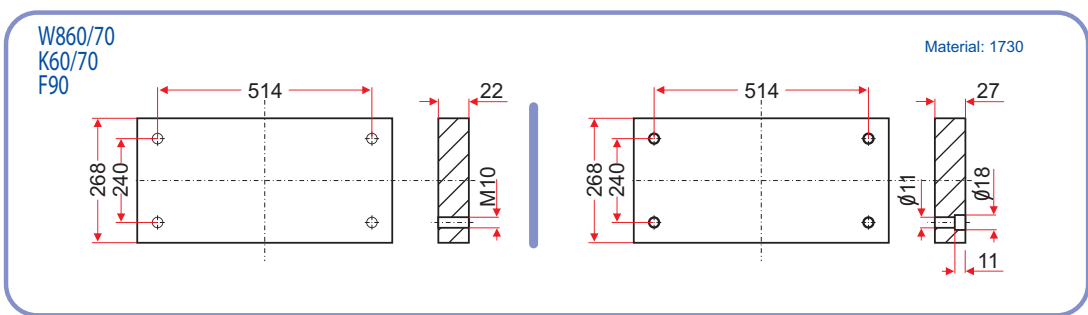
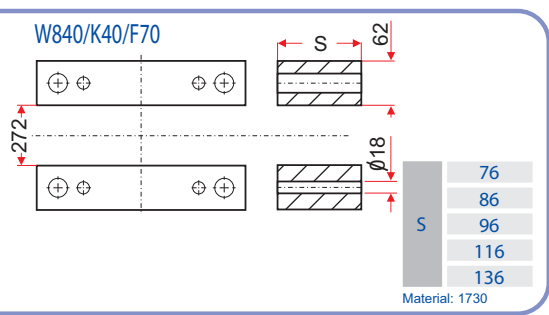
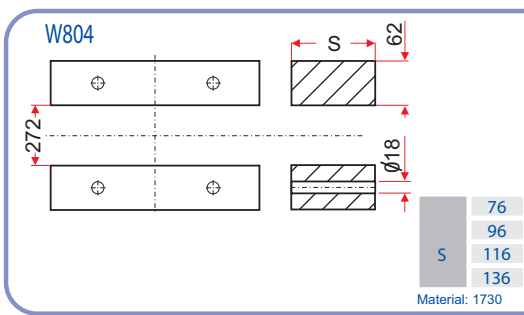
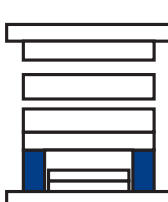
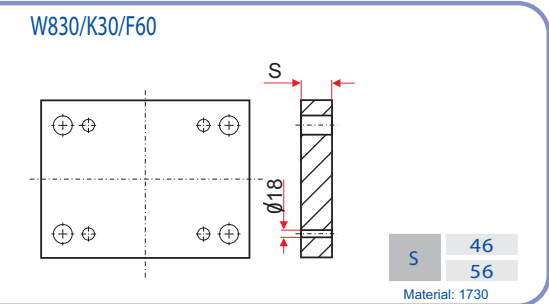
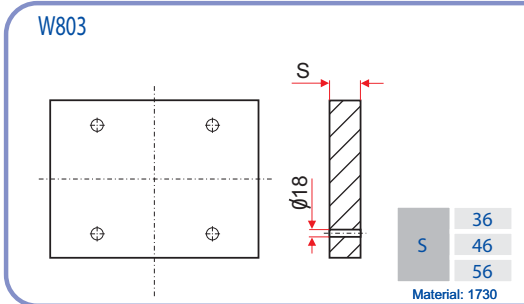
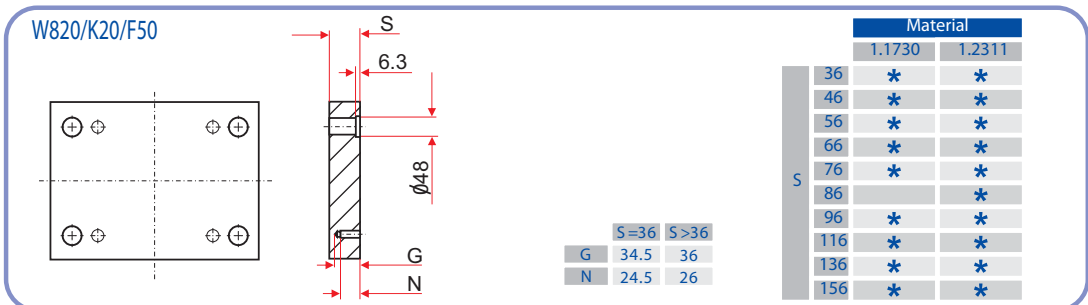
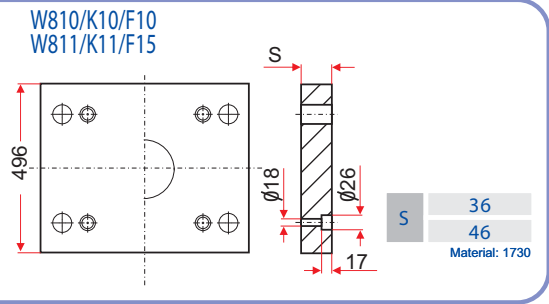
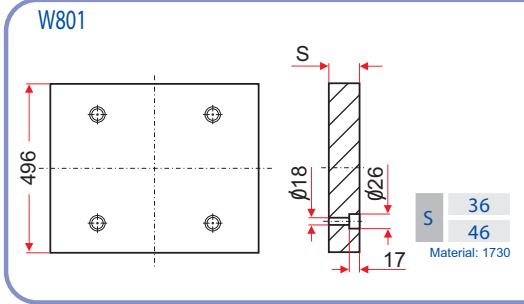

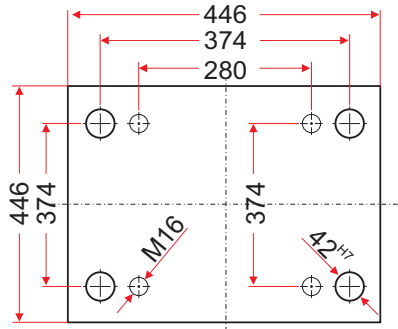

# 446.446

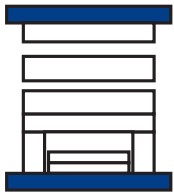

W801

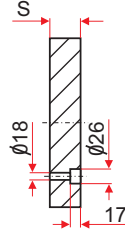
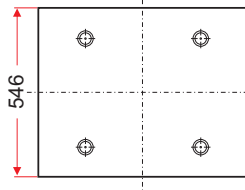

S	36
	46

Material: 1730

W810/K10/F10  
W811/K11/F15

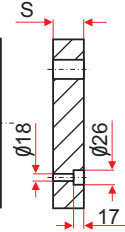
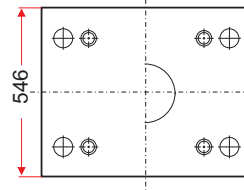

S	36
	46

Material: 1730



W820/K20/F50

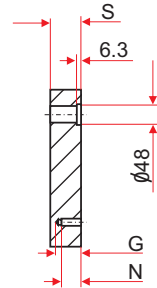
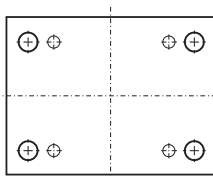

	S=36	S>36
G	34.5	36
N	24.5	26

S	Material		
	1.1730	1.2311	1.2738
36	*	*	*
46	*	*	*
56	*	*	*
66	*	*	*
76	*	*	*
86	*	*	*
96	*	*	*
116	*	*	*
136	*	*	*
156	*	*	*

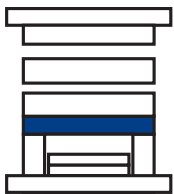

W803

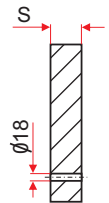
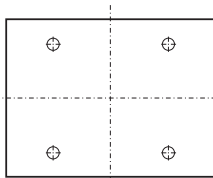

S	36
	46

Material: 1730

W830/K30/F60

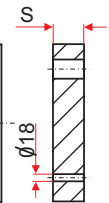
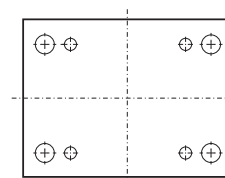

S	36
	46

Material: 1730

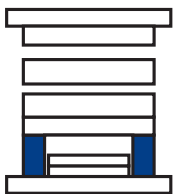

W804

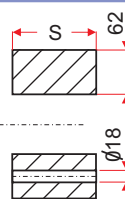
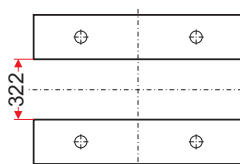

S	56
	76
	96
	116

Material: 1730

W840/K40/F70

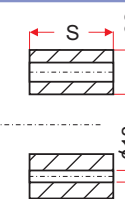
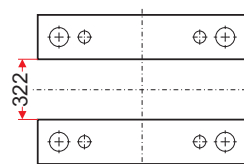

S	56
	66
	76
	86
	96
	116

Material: 1730

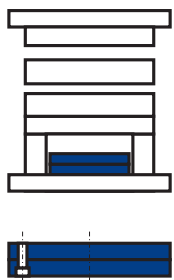

W860/70  
K60/70  
F90

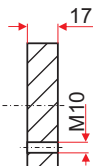
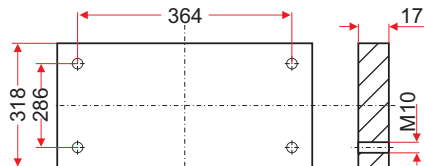

Material: 1730

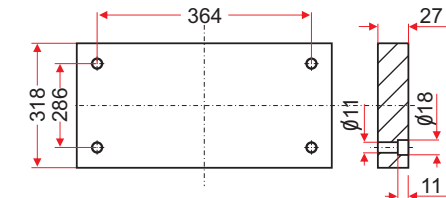

Material: 1730

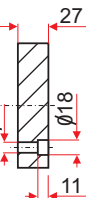

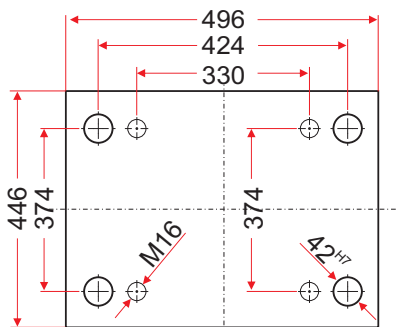

# 446.496

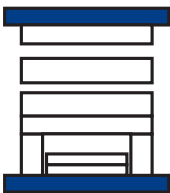

W801

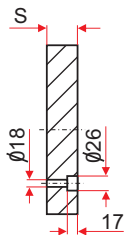
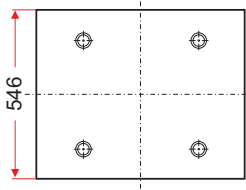

S	36
	46

Material: 1730

W810/K10/F10  
W811/K11/F15

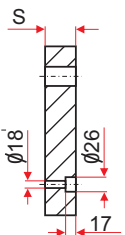
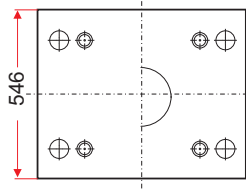

S	36
	46

Material: 1730



W820/K20/F50

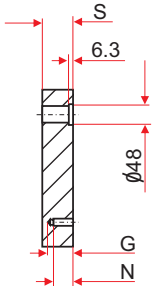
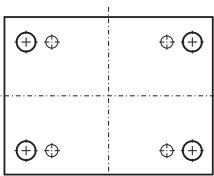

S=36		S>36
G	34.5	36
N	24.5	26

		Material		
		1.1730	1.2311	1.2738
S	36	*	*	*
	46	*	*	*
	56	*	*	*
	66	*	*	*
	76	*	*	*
	86	*	*	*
	96	*	*	*
	116	*	*	*
	136	*	*	*
	156	*	*	*

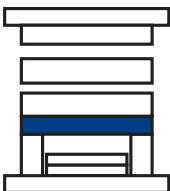

W803

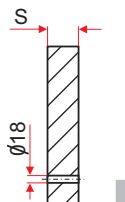
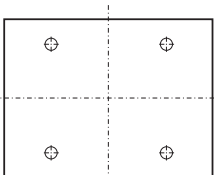

S	36
	46

Material: 1730

W830/K30/F60

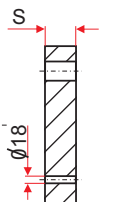
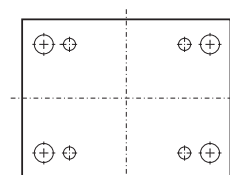

S	36
	46

Material: 1730

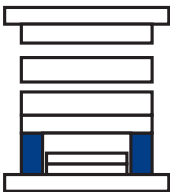

W804

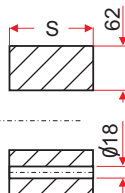
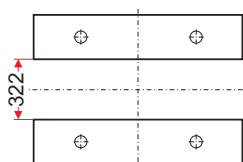

S	76
	96
	116
	136

Material: 1730

W840/K40/F70

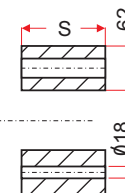
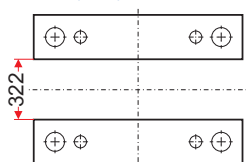

S	76
	86
	96
	116
	136

Material: 1730

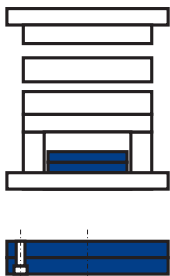

W860/70  
K60/70  
F90

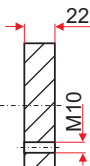
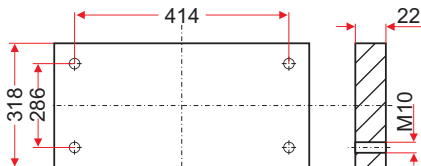

Material: 1730

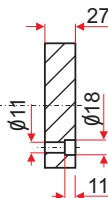
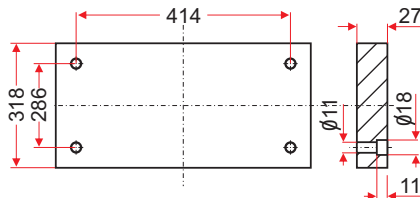

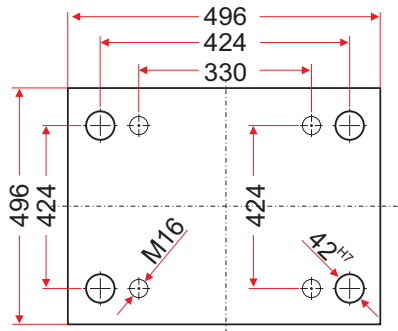

# 496.496

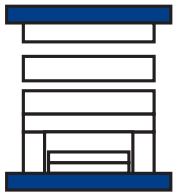

W801

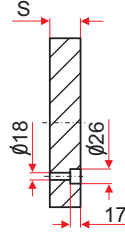
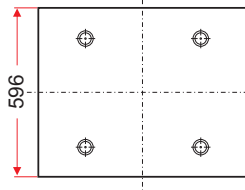

S	36
	46

Material: 1730

W810/K10/F10  
W811/K11/F15

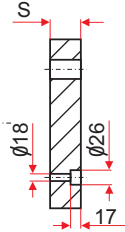
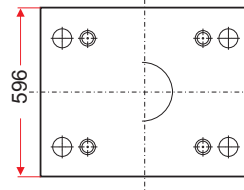

S	36
	46

Material: 1730



W820/K20/F50

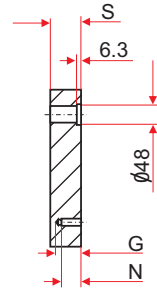
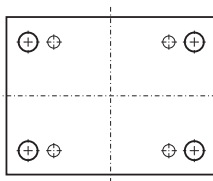

	S=36	S>36
G	34.5	36
N	24.5	26

S	Material		
	1.1730	1.2311	1.2738
36	*	*	*
46	*	*	*
56	*	*	*
66	*	*	*
76	*	*	*
86	*	*	*
96	*	*	*
116	*	*	*
136	*	*	*
156	*	*	*

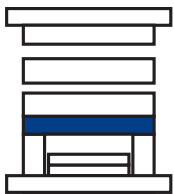

W803

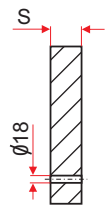
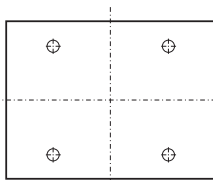

S	36
	46

Material: 1730

W830/K30/F60

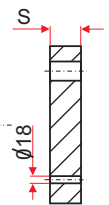
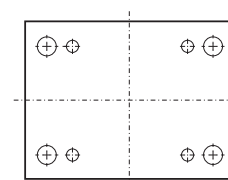

S	36
	46

Material: 1730

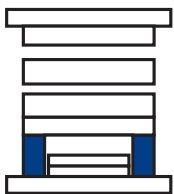

W804

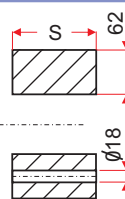
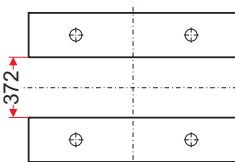

S	56
	76
	96
	116
	136

Material: 1730

W840/K40/F70

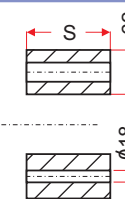
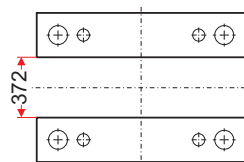

S	76
	86
	96
	116
	136

Material: 1730

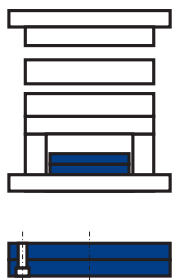

W860/70  
K60/70  
F90

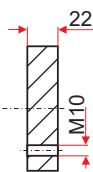
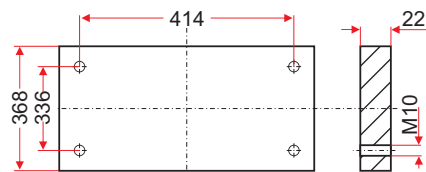

Material: 1730

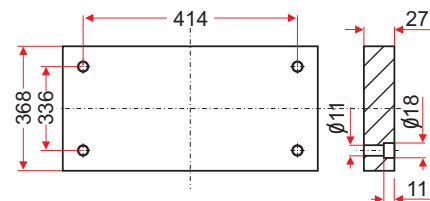



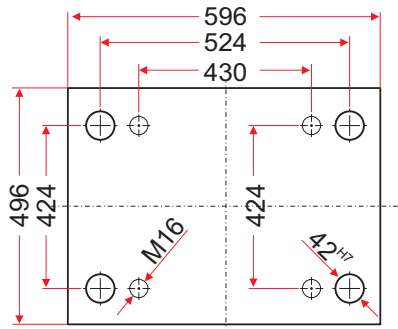

# 496.596

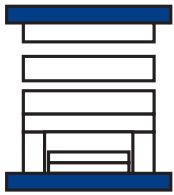

W801

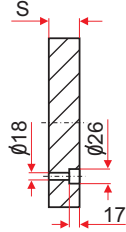
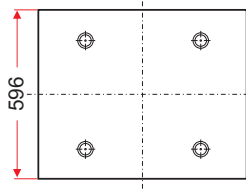

S	36
	46

Material: 1730

W810/K10/F10  
W811/K11/F15

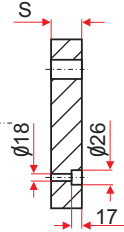
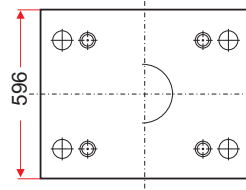

S	36
	46

Material: 1730



W820/K20/F50

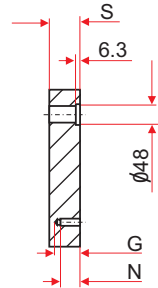
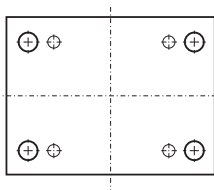

	S=36	S>36
G	34.5	36
N	24.5	26

Material	Material		
	1.1730	1.2311	1.2738
S	46	*	*
	56	*	*
	66	*	*
	76	*	*
	86	*	*
	96	*	*
	116	*	*
	136	*	*
	156	*	*

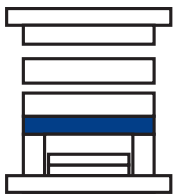

W803

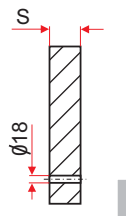
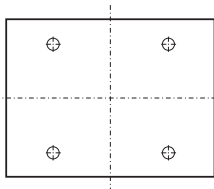

S	36
	46

Material: 1730

W830/K30/F60

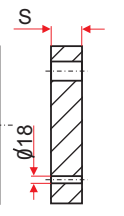
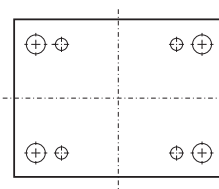

S	36
	46

Material: 1730

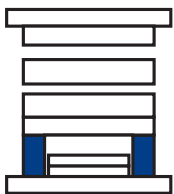

W804

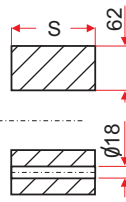
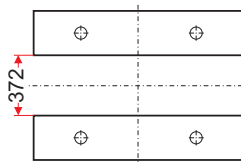

S	76
	96
	116
	136

Material: 1730

W840/K40/F70

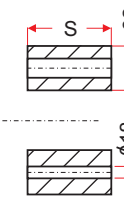
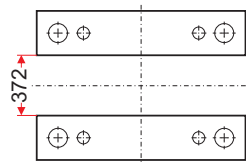

S	76
	86
	96
	116
	136

Material: 1730

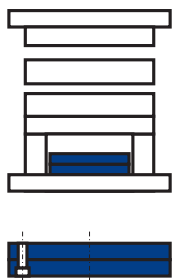

W860/70  
K60/70  
F90

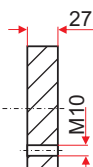
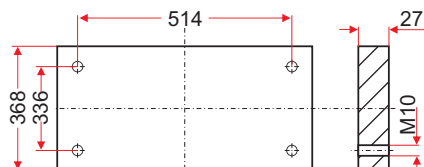

Material: 1730

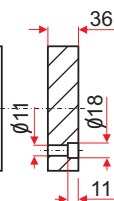
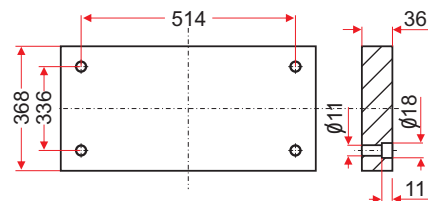

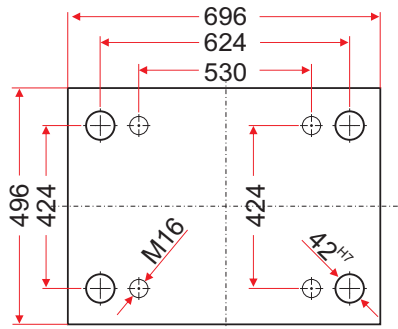

# 496.696

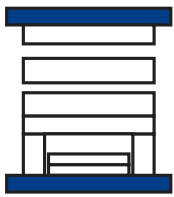

W801

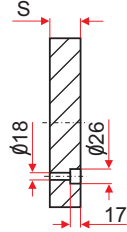
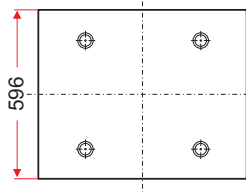

S	46
	56

Material: 1730

W810/K10/F10  
W811/K11/F15

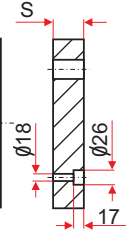
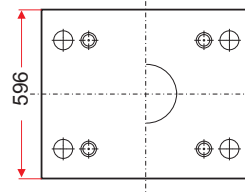

S	46
	56

Material: 1730

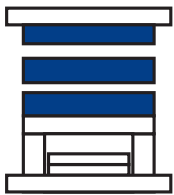

W820/K20/F50

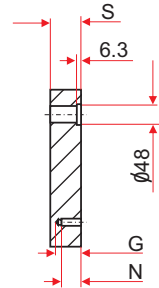
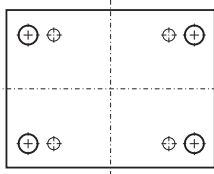

	S=36	S>36
G	34.5	36
N	24.5	26

Material

	1.2311
S	76 *
	86 *
	96 *
	116 *
	136 *
	156 *

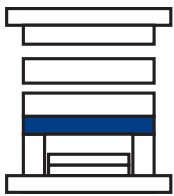

W803

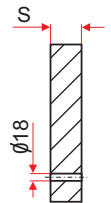
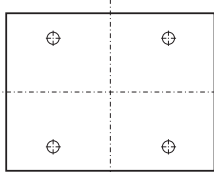

S	46
	56

Material: 1730

W830/K30/F60

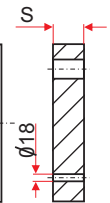
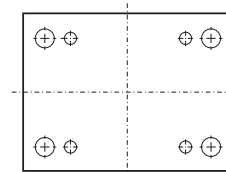

S	46
	56

Material: 1730

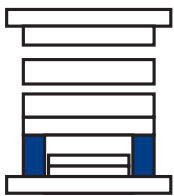

W804

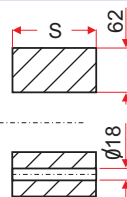
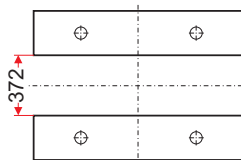

S	76
	96
	116
	136
	156

Material: 1730

W840/K40/F70

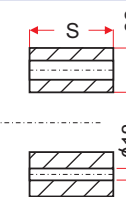
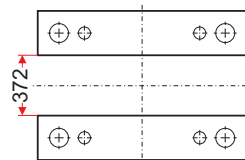

S	76
	86
	96
	116
	136
	156

Material: 1730

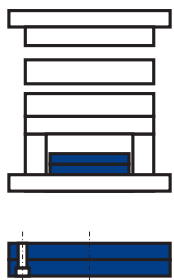

W860/70  
K60/70  
F90

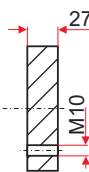
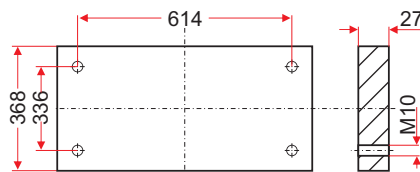

Material: 1730

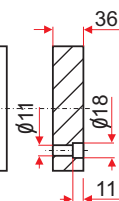
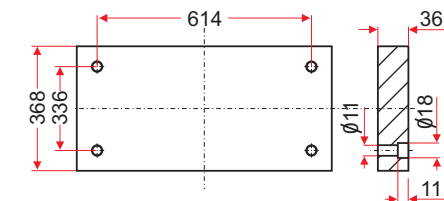

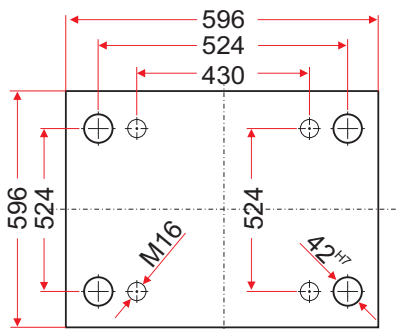

# 596.596



W801

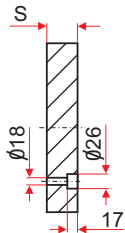
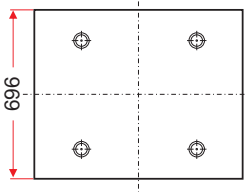

S	46
	56

Material: 1730

W810/K10/F10  
W811/K11/F15

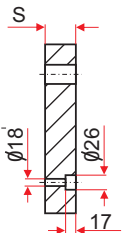
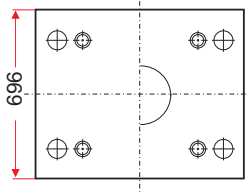

S	46
	56

Material: 1730



W820/K20/F50

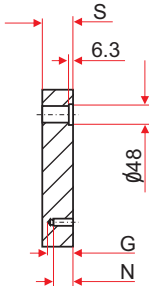
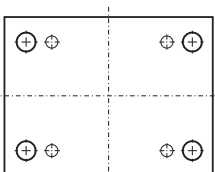

S=36	S>36
G	34.5 36
N	24.5 26

Material		
	1.1730	1.2311
S	36	
	46	*
	56	*
	66	*
	76	*
	86	*
	96	*
	116	*
	136	*
	156	*

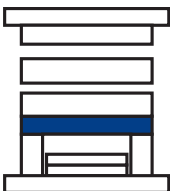

W803

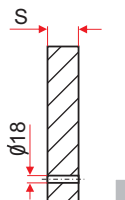
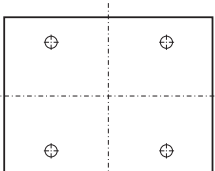

S	46
	56

Material: 1730

W830/K30/F60

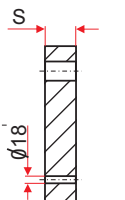
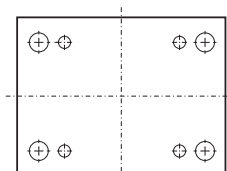

S	46
	56

Material: 1730

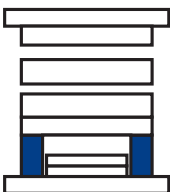

W804

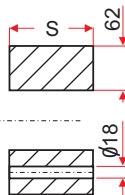
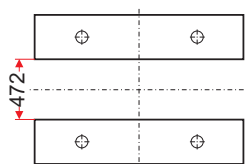

S	76
	96
	116
	136
	156

Material: 1730

W840/K40/F70

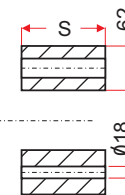
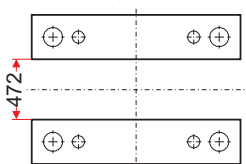

S	76
	86
	96
	116
	136
	156

Material: 1730



W860/70  
K60/70  
F90

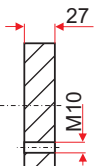
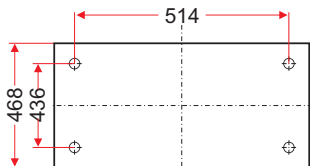

Material: 1730

